

PRO 2

Operation Manual



Dave Smith
I N S T R U M E N T S

PRO 2

Operation Manual

Version 1.2

April 2017

Dave Smith Instruments LLC
1527 Stockton Street, 3rd Floor
San Francisco, CA 94133
USA

©2017 Dave Smith Instruments LLC
www.davesmithinstruments.com



Tested To Comply
With FCC Standards
FOR OFFICE USE



This device complies with Part 15 of the FCC Rules. Operation is subject to the following two conditions: (1) This device may not cause harmful interference and (2) this device must accept any interference received, including interference that may cause undesired operation.

This Class B digital apparatus meets all requirements of the Canadian Interference-Causing Equipment Regulations.

Cet appareil numérique de la classe B respecte toutes les exigences du Règlement sur le matériel brouilleur du Canada.

For Technical Support, email: support@davesmithinstruments.com

Table of Contents

Thank You	ix
Getting Started	1
Sound Banks	1
Using the Display	2
Using Show, Compare, and Revert Parameter	3
Creating a Program from Scratch	3
Saving Programs	4
Using the Pro 2 in Paraphonic Mode	5
Moving to the Next Level	6
Connections	8
Global Settings	10
Oscillators	15
Character	23
Filter 1 & 2	24
Filter Envelopes 1 & 2	27
Amplifier Envelope	30
Auxiliary Envelopes 4 & 5	33
Feedback	35
Delay	36
Creating Reverb and Modulation-Based Effects	38

Low Frequency Oscillators	40
Modulation	45
Using the Assign Mod Buttons	46
Arpeggiator	47
Sequencer	50
Programming the Sequencer	50
Adding Rests, Ties, and Velocity	54
Sequencer Parameters	57
Master Volume/Voice Volume	61
Distortion	62
Glide	63
Pitch and Modulation Wheels	65
Touch Sliders	67
Play List	69
Cue	70
Misc Parameters	71
Using USB	72
A Few Tutorials	73
Processing External Audio	73
Filtering External Audio Using the Envelope Follower	74
Syncing the Sequencer with an External MIDI Device	75
Using Pro 2's CV Outs to Control a Modular Synth	76
More About Pro 2's CV Outputs	77
Look for More Tutorials Online	79

Appendix A:
Modulation Sources80

Appendix B:
Modulation Destinations.81

Appendix C:
Delay Times (Delays 1-3)84

Appendix D:
MIDI Implementation87
 MIDI Messages 88
 NRPN Messages 93
 Sysex Messages. 134
 Packed Data Format. 137

Appendix E: Support.138
 Troubleshooting 138
 Contacting Technical Support 139
 Warranty Repair 140

Credits and Acknowledgements

Sound Design

Rory Dow	Peter M. Mahr	Robert Rich
Peter Dyer	Tim Mantle	Matia Simovich
Keith Hillebrandt	Cord Mueller	James Terris
Kurt Kurasaki	Drew Neumann	Taiho Yamada
Kevin Lamb	Bob Oxley	

The DSI Crew

Ashley Bellouin, Bob Coover, Carson Day, Chris Hector, Tony Karavidas, Mark Kono, Andrew McGowan, Joanne McGowan, Tracy Wadley, and Mark Wilcox.

Special thanks to Tom Oberheim!

Thank You

No doubt about it: It's an exciting time to be a synth geek. You only have to look around you to realize that we're experiencing a renaissance of sorts for synthesizers. From stompboxes to modulars, synths are here in a very big way.

With the current demand for all things analog, I've been asked many times if I would ever consider reissuing the Pro-One monosynth. My response has always been the same: "You've got to keep moving forward." The simple truth is, I'm happiest creating new instruments—synths that put more power and better sounds into the hands of musicians with every iteration.

But actions speak louder than words, so here's the last one on that particular subject: *the Pro 2*. It's light years beyond the Pro-One in every way and is the culmination of my many years designing synthesizers. It's also the deepest and most powerful monosynth I've ever created, so it should keep you busy exploring the outer limits of sound for quite some time.

I really hope you enjoy playing it as much as we enjoyed designing it.

Thanks for the purchase, from all of us here at DSI!

Cheers,

DAVE SMITH



Getting Started

The Pro 2 is a *monophonic* synthesizer with the added capability of *paraphonic* operation. This means that while it was designed primarily with single-note operation in mind, you can actually play up to four notes simultaneously if you enable this feature. The Pro 2 uses a combination of digital and analog audio electronics to generate its sounds, making it a *hybrid* synthesizer. This allows us to design a tremendous amount of power and versatility into a very compact instrument. In fact, the Pro 2 offers so much flexibility that it rivals many modular synthesizers.

You can find in-depth information about each of the Pro 2's parameters in the *Reference* section of this manual. But don't hesitate to dive right in and start turning knobs and pressing buttons before you begin reading. You won't break anything and you can always get back to where you started, even if you have no idea what you're doing. So start exploring and keep your ears and mind open!

Sound Banks

The Pro 2 contains 792 programs organized into 8 banks of 99 sounds. Half of its programs are in 4 *Factory* banks and the rest are in 4 *User* banks. The Factory banks are permanent. The User banks can be overwritten. You can edit programs in either bank, but you can only save them to the User bank.

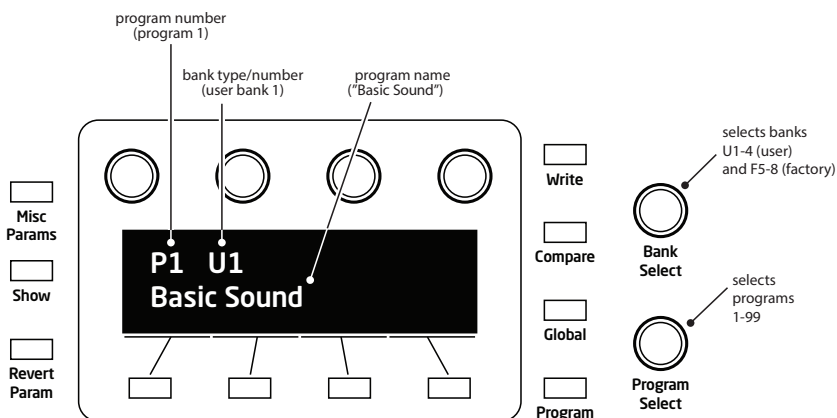

To choose a program:

1. Turn the Bank Select knob to choose a bank (“U” indicates a User bank; “F” indicates Factory).
2. Turn the Program Select knob to choose a program number.
3. Play the keyboard to audition the sound.



If you tweak any knobs or switches, the display will switch to a parameter display screen. You can always continue choosing programs with the PROGRAM SELECT knob.

Using the Display

The Pro 2’s main parameters are accessible through its front panel knobs and switches, but there are many additional parameters (as well as numeric display of values) accessible through the OLED display.

For example, adjusting a knob or switch in the Oscillator section reveals the value of that parameter in the display. The display also reveals additional oscillator parameters not found on the front panel. You can select and edit these additional parameters using the four *soft knobs* and *soft keys* located above and below the display.

The soft knobs are detented encoders that are useful for dialing in values with precision. The soft keys select between various tabs.

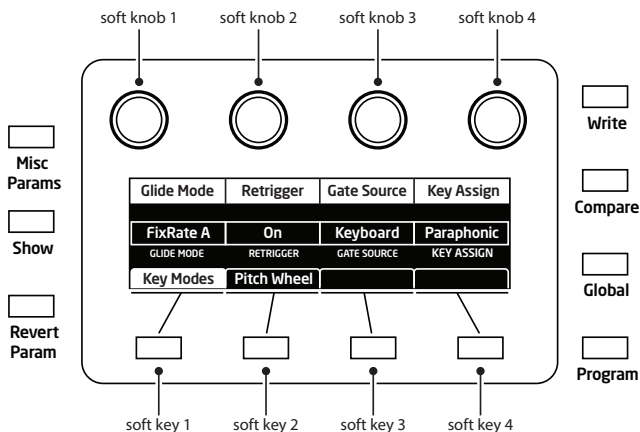

Using Show, Compare, and Revert Parameter

Any time you turn a front panel knob or press a switch, the value of that parameter will appear in the OLED display. Often you will want to inspect the value of a parameter without actually turning a knob (which changes the parameter value).

To show a parameter value without changing it:

1. Hold down the **SHOW** button and turn a knob or press a switch. The current value of the parameter appears in the display.
2. To inspect multiple parameter settings, press the **SHOW** button once to turn it on. Adjust as many knobs or switches as you want to see their current settings. When you're finished, press the **SHOW** button again to turn it off.



Hold down the **SHOW** button and move the pitch wheel to see its bend range settings.

It's often useful while editing a program to compare its current edited state to its original saved version.

To compare an edited program to its original saved version:

- Press the **COMPARE** button and play the keyboard to hear the original version of the program. To return to the edited version, press the **COMPARE** button again to turn it off.

It is also useful to revert a single parameter to its original setting.

To revert a parameter to its original saved state:

- Press and hold the **REVERT PARAM** button. Turn a parameter knob. Release the **REVERT PARAM** button. The parameter is restored to its saved value.

Creating a Program from Scratch

Many sound designers use an existing program as a jumping off point for new sounds. But it's often equally useful to create a new sound from scratch. The Pro 2 makes this easy by providing a "Basic Program" in its Global menu. This preset is very simple, with a single oscillator as its basis, and has only basic modulation routings set up.

To use the Basic Program:

1. Press the GLOBAL button.
2. Turn soft knob 1 to menu item 31: "Basic Program."
3. Press Soft Key 1 to execute the WRITE NOW command.
4. Start twiddling knobs to create something new. Don't forget to save your program (see below).

Saving Programs

If you've created or edited a sound that you like, you will want to save it. Saving a program overwrites a previously saved program. Sound designers often save dozens of incremental versions of a program as they continue to refine it. These intermediate versions often make good jumping off points for new sounds.



Before saving a sound to a chosen Bank or Program location, you can preview the program currently at that destination by pressing the COMPARE button. This is a very useful way to decide whether or not to overwrite an existing sound with a new one.

To save a program:

1. Press the WRITE button.
2. Turn the Bank Select knob (or soft knob 1) to choose a User bank ("U" indicates a User bank; "F" indicates a non-overwritable Factory bank).
3. Turn the Program Select knob (or soft knob 2) to select a program number within the chosen User bank.
4. Enter a name for the program using the appropriate Soft knobs and Soft keys (see the illustration below for their functions).
5. Press the WRITE button a second time. The program is saved.

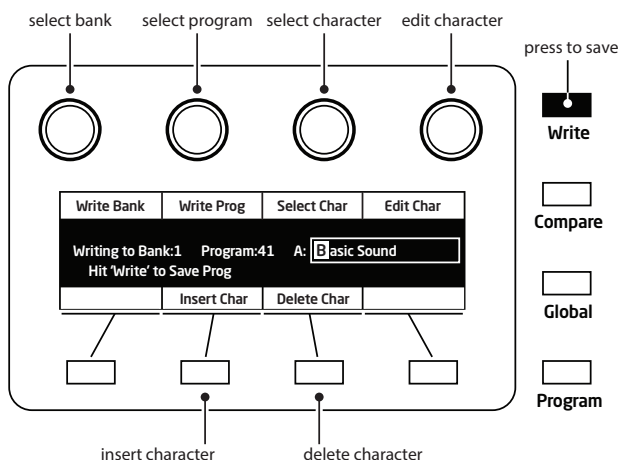

Sometimes you may want to cancel saving a program before you commit.

To cancel the save process before you commit:

- Press the PROGRAM button. You can return to editing if you want.

Using the Pro 2 in Paraphonic Mode

The Pro 2 was designed primarily as a monophonic instrument. But we added a 4-voice paraphonic playback mode for extra performance power. In this mode, the four main oscillators can be triggered independently, each with its own envelope. The two filters are shared in common between the four oscillators. This effectively gives you the ability to play chords of up to 4 notes.



For full 4-note paraphony, make sure that a waveshape is selected for each oscillator. Each oscillator is triggered with an envelope set by the VCA shape. Set the output level of the oscillators in this mode using the QUAD LEVEL parameter. To access this parameter, turn the OSCILLATOR 1 SUB OCTAVE knob on the front panel.

Sub Osc	Quad Level	Attack	Release
80	99	25	40
<small>SUB OSC</small>	<small>QUAD LEVEL</small>	<small>ATTACK</small>	<small>RELEASE</small>
<small>Sub Osc</small>	<small>Ext Input</small>	<small>Air/Girth</small>	<small>Char FX</small>

To enable 4-voice paraphonic playback:

1. Press the MISC PARAMS button.
2. Press soft key 1 to select the KEY MODES tab.
3. Turn soft knob 4 (KEY ASSIGN) to PARAPHONIC.
4. Play some chords.



With clever programming you can create some very rich sounds that work well in paraphonic mode. Add a bit of pulse width modulation or chorused delay and surprisingly lush string and pad sounds are easily within reach.

Moving to the Next Level

The Pro 2 is a deep instrument filled with nearly limitless possibilities for sound creation. Although we realize that you'd rather spend your time exploring its capabilities, we'd like to quickly point you toward a few things that will help you tailor the instrument to your needs.

First, check out the *Global Settings* section of this manual. Read about Pot Modes and determine which works best for you. You'll also find information about MIDI setup. Read this to more effectively integrate the Pro 2 into your rig. To get the most out of the Pro 2's live performance capabilities, read up on using a footswitch or expression pedal.

And finally, be on the lookout for tips and notes scattered throughout this manual to gain a better working knowledge of the Pro 2. The better you know your instrument, the more you'll get out of it. We wish you many hours of musical exploration!

Connections

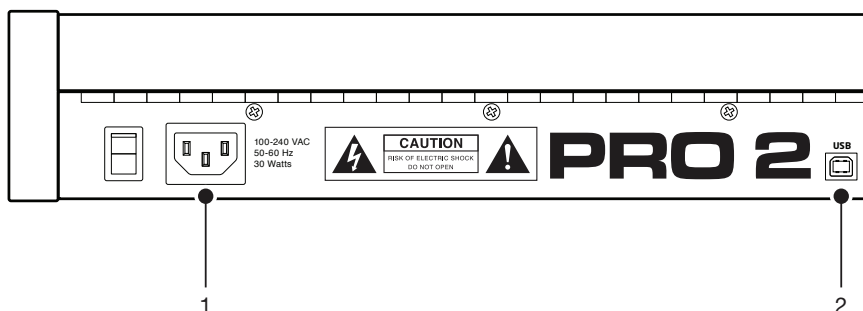

1. AC Power Connector—Accepts a standard, grounded IEC power cord. Operates over a range of 100 to 240 volts and 50 to 60 Hz.

2. USB—For bidirectional MIDI communication with a computer. The Pro 2 is a Class Compliant USB device and does not require additional drivers when used with Mac OS or Windows. See *Using USB* on page 72 for more information.

3. MIDI In, Out, and Thru/Out 2—Standard 5-pin MIDI DIN connectors.



The MIDI Thru/Out 2 jack can function as either a standard MIDI Thru or as a second MIDI output. To choose the functionality you want, press the GLOBAL button and scroll to item 12: MIDI PORT 2 THRU/OUT and select the desired option.

4. Footswitch—Accepts a momentary, normally open or normally closed footswitch to control sustain or to turn the arpeggiator on and off. See “Footswitch” under *Global Settings* on page 12 for more information.

5. Pedal—Accepts a standard expression pedal that has a variable resistor on a TRS (tip-ring-sleeve) ¼ inch phone plug. For more information, see “Pedal Function” in *Global Settings* on page 10.

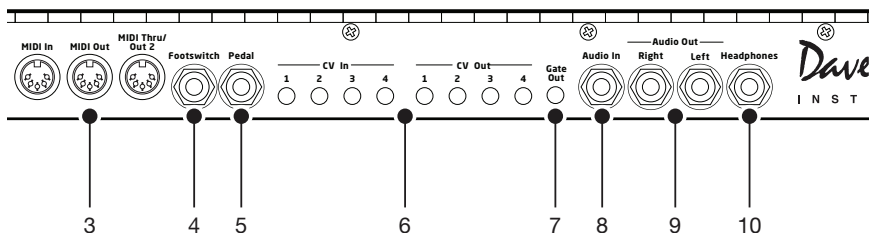

6. Control Voltage Ins and Outs 1-4—Standard $\frac{1}{8}$ inch TS connectors. These jacks input and output a scalable 1-volt-per-octave signal for interfacing with modular synthesizers and other gear that recognize this standard.

7. Gate Out—Standard $\frac{1}{8}$ inch TS connector. This jack outputs a 10 volt on/off signal for triggering external sequencers and other devices that support this type of connectivity.

8. Audio In—Unbalanced, $\frac{1}{4}$ inch audio input. The Pro 2 accepts external audio signals for processing through this connector. Input level can be adjusted using the EXT. INPUT LEVEL knob in the Oscillators section.

9. Audio Outputs—Unbalanced, $\frac{1}{4}$ inch audio outputs. The Pro 2 sounds great in stereo, but can be switched to mono if needed. See “Mono/Stereo” in *Global Settings* on page 11.

10. Headphones—A $\frac{1}{4}$ inch stereo headphone jack.

Global Settings

Press the GLOBAL button to set parameters such as Master Tune and MIDI Channel that affect all programs globally.

- 1. Master Coarse Tune:** -12...+12—Master Transpose control, 0 is centered. Steps in semitones up to one octave up (+12) or down (-12).
- 2. Master Fine Tune:** -50...+50—Master Fine Tune control; 0 centered. Steps in cents as much as a quarter-tone up (+50) or down (-50).
- 3. MIDI Channel:** All, 1...16—Selects which MIDI channel to send and receive data, 1 to 16. All receives on all 16 channels.
- 4. MIDI Clock Mode:** Sets the Pro 2's ability to send and receive MIDI clock messages:

- Off: MIDI Clock is neither sent nor received
- Master: MIDI Clock is sent, but not received.
- Slave: MIDI Clock is received, but not sent.
- Slave Thru: MIDI Clock is received and passed to MIDI Out



In Slave and Slave Thru modes, if no MIDI clock is present at the selected input, the arpeggiator and sequencer will not function.

- 5. MIDI Clock Cable:** MIDI Port, USB—Sets the port, MIDI or USB, by which MIDI clocks are received.
- 6. MIDI Param Send:** Off, CC, NRPN—Changes to the values of front panel controls are transmitted via MIDI as Non-registered Parameter Number (NRPN) controllers or as Continuous Controllers (CC). Transmission of parameters can also be turned off. See *MIDI Implementation* on page 87 for details.



NRPNs are the preferred method of parameter transmission, since they cover the complete range of all parameters, while CCs are limited to a range of 128.

- 7. MIDI Param Receive:** Off, CC, NRPN—Sets the method by which parameter changes are received via MIDI. As with transmission, NRPNs are the preferred method.

- 8. MIDI Control Enable:** Off, On—When On, the synth will respond to MIDI controllers, including Pitch Wheel, Mod Wheel, Pedal, Breath, Volume, and Expression.
- 9. MIDI Sysex Enable:** Off, On—When On, the synth will respond to received MIDI SysEx messages, and will transmit them, when prompted, to the MIDI Out. See *Sysex Messages* on page 134 for details.
- 10. MIDI Sysex Cable:** None, MIDI Port, USB—Sets the port, MIDI or USB, by which System Exclusive data will be transmitted and received.
- 11. MIDI Out Select:** Off, MIDI, USB, MIDI+USB—Sets the port by which MIDI data will be transmitted.
- 12. MIDI Port 2 Thru/Out:** Out, Thru—Selects whether the MIDI THRU/OUT 2 port outputs a second, user-selectable MIDI channel or outputs the MIDI data received on the MIDI In port.
- 13. Local Control:** Off, On—When on (the default), the keyboard and front panel controls directly affect the Pro 2. When off, the controls are transmitted via MIDI but do not directly affect the “local” synth (that is, the Pro 2). This is primarily useful for avoiding MIDI data loops that can occur with some external sequencers.
- 14. Mono/Stereo:** Stereo, Mono—The Pro 2 defaults to stereo operation. When set to Mono, this parameter defeats all pan settings and modulation, effectively making each of the outputs a mono output.
- 15. Pot Mode:** Relative, Passthru, Jump—The rotary controls on the Pro 2’s front panel are a mixture of “endless” rotary encoders and potentiometers or “pots.” The pots are identifiable by their lined knobs and the fact that they have about 300° of travel. There are three pot modes to determine how the synth reacts when the programmable parameters are edited. (Master volume is not programmable, so these modes don’t apply.)

When set to Relative, changes are relative to the stored setting. In Relative mode, the full value range is not available until either the minimum or maximum value and the respective lower or upper limit of the pot’s travel is reached.

For example, the RESONANCE parameter has a value range of 0 to 127. Let's say the physical position of the RESONANCE pot is the equivalent of a value of 100. If you switch to a program that has a stored Resonance setting of 63 and turn the pot all the way up, it will only go to 90. To get to the maximum value of 127, you first have to turn down until the value is at the other extreme and the pot is at the limit of its travel (in this case, 0 and fully counter-clockwise, respectively).

In Passthru mode, turning the pot has no effect until after the edited value equals the preset value (that is, until the edited value “passes through” the stored value).

Jump mode uses an absolute value based upon the position of the pot when edited: turn a pot and the value jumps immediately from the stored value to the edited value.

16. Footswitch Polarity: Normal, Reversed—There are two types of momentary footswitches, normally open and normally closed. Either type can be used with the Pro 2's Sustain switch input. Not sure which type you have? If the behavior of the footswitch is the opposite of what is expected—that is, down is off and up is on—changing this setting will correct that.

17. Footswitch Function: Sustain, Arp Hold On/Off—The footswitch can be used for sustain or to turn arpeggiator hold on and off.

18. Pedal Polarity: Normal, Reversed—This allows you to accommodate certain models of expression pedals that behave in a way that is the opposite of what you might expect due to their polarity. (Pressing down on the pedal decreases rather than increases modulation, for example.) If this is the case with your expression pedal, choose the appropriate setting to correct it.

19. Pedal Function: Breath Control, Foot Controller, Expression, Master Volume, Filter 1+2: Full Range, Filter 1+2 Filter: Half Range—Sets the function/destination for the Pedal 1 input. An expression pedal can be routed to any destination using the modulation matrix. See *Modulation* on page 44 for more information.

20. Aftertouch Enable: Off, On—When on, the Pro 2 will receive and transmit aftertouch data via MIDI.

21. Aftertouch Curve: Curve 1, Curve 2, Curve 3, Curve 4—Sets one of four pressure curves for the keyboard to adjust the aftertouch to your playing style.

22. Velocity Curve:—Curve 1, Curve 2, Curve 3, Curve 4—Sets one of the four velocity curves for the keyboard to adjust the velocity response to your playing style.

23. CV 1 In Scale: -127...+128—Allows adjustment of the input scale of control voltage input 1.



The Pro 2's oscillators can both drive and be driven by control voltages. Because the electronics in any device are rarely perfect, CV In and Out scaling allows you to make slight adjustments so that the Pro 2 and any connected CV devices are in tune with each other.



The Pro 2 is extremely flexible when it comes to Control Voltages, and it can be configured to accurately interact with virtually all Eurorack modules. The Pro 2's CV outputs have a range of 0 to 10v. Since the range is 0-10v, Middle C is sent from the CV output at 5v. This allows the CV out to track over a 10 octave range, from 0 to 10v. There is no standard input voltage range for Eurorack modules. Some modules and external synthesizers have a 10v input range, while others have a 5v input range. Using the DC OFFSET parameter in the Modulation Matrix, you can configure the Pro 2 as necessary to work correctly with your specific module. You can also assign the keyboard and sequencer of the Pro 2 to transmit CV data at 1v/octave by assigning NOTE NUMBER to modulate CV OUT (1-4) with an "Amount" of "127" in the Mod Matrix

24. CV 2 In Scale: -127...+128—Allows adjustment of the input scale of control voltage input 2.

25. CV 3 In Scale: -127...+128—Allows adjustment of the input scale of control voltage input 3.

26. CV 4 In Scale: -127...+128—Allows adjustment of the input scale of control voltage input 4.

27. CV 1 Out Scale: -127...+128—Allows adjustment of the output scale of control voltage output 1.

28. CV 2 Out Scale: -127...+128—Allows adjustment of the output scale of control voltage output 2.

29. CV 3 Out Scale: -127...+128—Allows adjustment of the output scale of control voltage output 3.

30. CV 4 Out Scale: -127...+128—Allows adjustment of the output scale of control voltage output 4.

31. Basic Program—Press Write Now (soft key 1) to load a basic, template program into the edit buffer. Use WRITE to permanently save to memory.

32. Calibrate Sliders—Press Start Cal (soft key 1) and follow the onscreen instructions to calibrate the sliders.

33. Calibrate Wheels—Press Start Cal (soft key 1) and follow the onscreen instructions to calibrate the wheels.

34. Autotune Filters—Press Start Tuning (soft key 1) and follow the onscreen instructions to tune filters 1 and 2.



The sliders, wheels, and filters are calibrated at the factory and under normal circumstances should not require re-calibration or re-tuning.

35. Reset Globals—Sets the global parameters to the factory default settings.

36. Dump Current Program—Transmits the current program in SysEx format via the selected MIDI port. (See “9. MIDI Sysex Cable.”) Dumped programs will load back into the same bank and program location in memory when received by the Pro 2 via MIDI.

37. Dump Current Bank—Transmits the current bank in SysEx format via the selected MIDI port. (See item 10, “MIDI Sysex Cable.”) Dumped banks will load back into the same bank location in memory when received by the Pro 2 via MIDI.

38. Dump All User Banks—Transmits all four User Banks in SysEx format via the selected MIDI port. (See item 10, “MIDI Sysex Cable.”) Dumped banks will load back into the same bank location in memory when received by the Pro 2 via MIDI.

Oscillators









Oscillators provide the raw building blocks of a synthesizer's sound by producing *waveforms*, each of which has its own inherent sound character based on its harmonic content. The Pro 2 has four oscillators (plus a sub oscillator for oscillator 1). These are capable of generating classic analog waveforms (sine, triangle, sawtooth, square) as well as more complex wavetable-derived wave shapes, different types of noise, and *super waves*, which are stacked, detuned versions of the wave shapes.

Oscillator buttons 1-4 select an individual oscillator for editing.



To edit the same parameter on all 4 oscillators simultaneously, press and briefly hold one of the oscillator select buttons. In this state, you can also use the soft knobs in the OLED display to individually edit the same parameter on each oscillator. To exit this mode, press any oscillator button.

OSCILLATORS

<input type="checkbox"/>	1				
<input type="checkbox"/>	2	Pitch	Shape/Noise	Output Level	Ext Input Level
<input type="checkbox"/>	3	<input type="checkbox"/>	Sync	<input type="checkbox"/>	Character
<input type="checkbox"/>	4				
		Fine	Shape Mod/ Pulse Width	Glide Amount	Oscillator 1 Sub Octave

In addition to the front panel controls, there are several parameters, such as FM AMOUNT, AM AMOUNT, WAVE LEFT and WAVE RIGHT that are accessed through the soft knobs and switches.

Shape	Shape Mod		
	10 SHAPE MOD	Tines WAVE LEFT	Nasal WAVE RIGHT
Osc Shape	Osc Tuning	Osc Mods	Osc Level

Pitch	Fine Tune	Wave Reset	Key Follow
C2 PITCH	0 FINE TUNE	<input type="checkbox"/> WAVE RESET	<input type="checkbox"/> KEY FOLLOW
Osc Shape	Osc Tuning	Osc Mods	Osc Level

FM Amount	AM Amount	Glide	Osc Slop
5 FM AMOUNT	0 AM AMOUNT	20 GLIDE	0 OSCSLOP
Osc Shape	Osc Tuning	Osc Mods	Osc Level

Level		Sync	
100 LEVEL		<input type="checkbox"/> SYNC	
Osc Shape	Osc Tuning	Osc Mods	Osc Level

Pitch: C 0...C 10—Sets the base oscillator frequency over a 10-octave range, from 8 Hz to 8KHz, stepping in semitones. C3 is middle C, the first octave is 0 (C0, C#0, etc.), the second octave is 1 (C1, C#1, etc.), and so on.



The global Master Tune settings affect the pitch of all oscillators. See *Global Settings* on page 10 for more information.

Fine: -50...+50—Fine tune control with a range of a quartertone up or down. Zero is centered. Steps are in cents (50 cents = 1/2 semitone).

Shape/Noise: Off, Sawtooth, Super Saw, Pulse, Triangle, Sine, Tines, Mellow, Church, Muted, Nasal, Boing, Gothic, Ahhh, Shrill, Ohhhh, Buzzzz, Meh, Super Tines, Super Mellow, Super Church, Super Muted, Super Nasal, Super Boing, Super Gothic, Super Ahhh, Super Shrill, Super Ohhhh, Super Buzzzz, Super Meh, Red Noise, White Noise, Violet Noise—Used to select the wave shape or type of noise generated by the selected oscillator. Wave shapes include four typical analog synthesizer waves as well as more complex wavetable sounds. There are also three types of noise: red, white, and violet.

Shape Mod/Pulse Width: -64...0...63—Causes the wave shape to be altered. How it changes depends upon the selected shape. A setting of 0 is the default, unaffected shape.

When Sawtooth is the selected shape, **SHAPE MOD/PULSE WIDTH** controls the symmetry of the wave, similar to pulse width on the Pulse wave.

SHAPE MOD/PULSE WIDTH affects the pulse width or duty cycle of the Pulse wave.

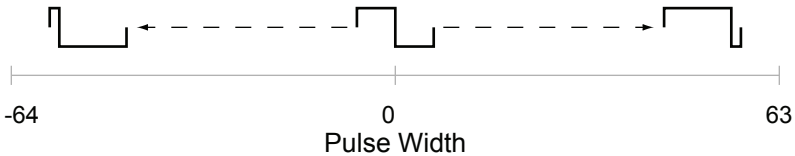

When Triangle is the selected shape, the width of the wave is changed, similar to Pulse and Sawtooth, adding harmonics and getting more thin sounding when turned in either direction from 0.

With Sine as the selected shape, values less than 0 gradually add another sine an octave higher than the base pitch. Values greater than 0 cause the sine wave to gradually be clipped, adding harmonics and sounding somewhat distorted.



When a super wave is selected as a waveshape (“super saw, for example), the **SHAPE MODE/PULSE WIDTH** parameter controls the amount of detuning of the super wave. Detuning thickens the super wave’s sound. Detuning range is from -64 to 63.

For the wavetable shapes, **SHAPE MOD/PULSE WIDTH** crossfades between the selected shape and the Wave Left and Wave Right selections. Let’s say, for example, that the selected wave shape is Mellow, Wave Left is set to Tines, and Wave Right is set to Nasal. A **SHAPE MOD/PULSE WIDTH** setting of -64 will be the Tines wave, 0 will be Mellow, and +63 will be Nasal. Values between -64 and 0 will be a mix of Tines and Mellow; values between 0 and +63 will be a mix of Mellow and Nasal.

A broad variety of hybrid wave shapes can be created by mixing two of the wavetable shapes. **SHAPE MOD/PULSE WIDTH** is also a modulation destination, so an LFO or other modulation source can be routed to it.

Note that the algorithm used to mix the waves is not simply a mix. If all three are set to the same wave, there will still be a noticeable difference in the sound as Shape Mod changes.

SHAPE MOD/PULSE WIDTH also works when noise is the selected shape. With a Shape Mod value of 0, the displayed noise type is what is heard. Values less than 0 gradually cause it to change to a second noise type. Values greater than 64 cause it to change to a third noise type. The left and right noise sources are fixed. Try it. It's much easier to hear than to explain! The display also provides a visual indication of the change.

Wave Left, Wave Right—(In the OSC SHAPE tab in the OLED display) Sets the wavetable shapes used in conjunction with the SHAPE MOD/PULSE WIDTH parameter. Wave Left and Wave Right are only active when one of the twelve wavetables is selected as the primary oscillator shape. See “Shape Mod/Pulse Width” for more information.

Output Level: 0...127—Sets the output level for each of the oscillators.



When using three or four oscillators, it may be necessary to reduce the levels of each to avoid clipping.

Glide Amount: 0...127—Sets the oscillator glide (*portamento*) amount. Glide can be set independently for each oscillator. Low values are shorter/faster. The GLIDE switch must be on to hear the effect of GLIDE AMOUNT. For a detailed explanation, see *Glide* on page 62.



To set GLIDE AMOUNT for all oscillators simultaneously, press and briefly hold any of the oscillator select buttons until all of them are lit. Then adjust GLIDE AMOUNT. Press any oscillator select button to exit.

Ext Input Level: 0...127—Controls the volume level of any signal connected to the AUDIO IN jack on the rear panel of the Pro 2. When connecting low-level output devices such as guitars use the EXTERNAL INPUT GAIN control (see below) to boost their gain if necessary. If nothing is connected to the AUDIO IN jack, the EXT INPUT LEVEL control functions as a feedback path and feeds the Pro 2's audio back into itself. Turning it up can yield interesting results.

Ext Input Gain: 0...127—(In the *EXT INPUT* tab in the *OLED* display)

Boosts the input level of any signal connected to the *AUDIO IN* connector on the rear panel of the Pro 2. This is useful for increasing the gain of low-level output devices such as guitars.

Threshold: 0...127—(In the *EXT INPUT* tab in the *OLED* display) Sets the threshold above which external input signals will trigger the Pro 2's Gate and envelope follower. Triggering these from an external input allows you to drive the Pro 2's envelopes, sequencer steps, and more with guitars, drum machines and so on.

Oscillator 1 Sub Octave: 0...127—(In the *SUB OSC* tab) Controls the level of a sine wave oscillator pitched one octave below oscillator 1. Because a sine wave has few harmonics and is mainly characterized by its fundamental frequency, adding a sub octave to sounds such as bass are a great way to increase their low-register presence.

Sub Osc	Quad Level	Attack	Release
80 SUB OSC	99 QUAD LEVEL	25 ATTACK	40 RELEASE
Sub Osc	Ext Input	Air/Girth	Char FX

ENVELOPE FOLLOWER

Quad Level: 0...127—(In the *SUB OSC* tab) Access this parameter by turning the *OSC 1 SUB OCTAVE* knob. Controls the overall output level of a paraphonic program.

(Envelope Follower) Attack: 0...127—(In the *SUB OSC* tab) Access this parameter by turning the *OSC 1 SUB OCTAVE* knob. Sets the attack speed of the envelope follower.

(Envelope Follower) Release: 0...127—(In the *SUB OSC* tab) Access this parameter by turning the *OSC 1 SUB OCTAVE* knob. Sets the release speed of the envelope follower.

Sync: Off, On—Turns oscillator hard sync on. Sync utilizes pairs of oscillators to force one oscillator (the slave) to restart its cycle every time the other oscillator (the master) starts a cycle. This provides a way to create more complex, harmonically rich shapes from simple waveforms.

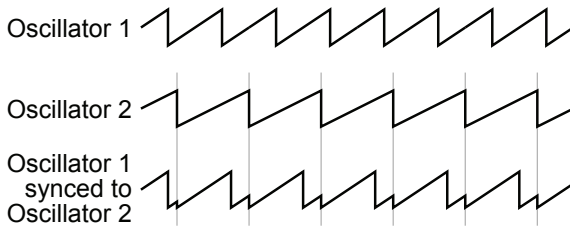

The following table shows how the oscillators are paired.

Master Osc	controls	Slave Osc
2	→	1
3	→	2
4	→	3
1	→	4

The effect of Sync is much more easily heard than explained. Here's a simple example of how to use Sync.

1. Load the Basic Program from the Global menu. Oscillator 1 **SHAPE** is set to sawtooth and oscillators 2, 3, and 4 are off.
2. With oscillator 1 selected, press the **SYNC** button to turn oscillator 1 sync on.
3. Now turn oscillator 1 **PITCH** while playing the keyboard. The harmonic content changes, but not the fundamental pitch. Now select oscillator 2 and do the same thing while turning oscillator 2 **PITCH**. (Remember: only oscillator 1 should actually be audible.) The fundamental pitch changes, but the harmonic content is relatively consistent. Oscillator 2 is the master and oscillator 1 is the slave.



Use glide, an envelope generator, an LFO, the mod wheel, or other modulation source to sweep the pitch of a slave oscillator.

Of course, each of the four oscillators can be synced, so it's possible to have two pairs of synced oscillators or to sync oscillators in series (an oscillator synced to a synced oscillator, synced to a synced oscillator...).



The OSCILLATOR 1 SUB OCTAVE does not sync to oscillator 2. To sync oscillator 1 and have a sub octave that plays in tune with oscillator 2, use one of the other oscillators as a sub.

Wave Reset: Off, On—(In the OSC TUNING tab in the OLED display)

When Wave Reset is off, the Pro 2's oscillators are free running, which is typically how analog synths behave. That is, the oscillators are running whether a note is being gated on or not. When the amplifier envelope is set for a fast attack, this can cause a soft, but detectable, pop or click at the beginning of a note because the note might be gated on at a point in the wave's cycle other than a zero crossing. The first cycle to play might be truncated. For some sounds, like monophonic basses, this may actually be desirable. It adds a bit of randomness to the attack that can make it sound more organic. When Wave Reset is on, the wave is always reset to zero—the start of its cycle—when a note is gated on.

Key Follow: Off, On—(In the OSC TUNING tab in the OLED display)

When Key Follow is on, the oscillator tracks the keyboard or note data received via MIDI. When off, the oscillator plays at its base frequency setting, though the pitch may be affected by modulation from other sources.

Frequency Modulation (FM): 0...127—(In the OSC MODS tab in the OLED display) Allows one oscillator (the *modulator* in FM synthesis terms) to modulate the frequency of another oscillator (the *carrier*). The following table shows the modulator/carrier relationship between the oscillators.

Carrier	Modulator
Oscillator 1	Oscillator 2
Oscillator 2	Oscillator 3
Oscillator 3	Oscillator 4
Oscillator 4	Oscillator 1

Turning up FM for oscillator 1 causes it to be modulated by oscillator 2, turning up FM for oscillator 2 causes it to be modulated by oscillator 3, and so on.



The indicated order of modulation is really just a handy shortcut. In fact, you can route any oscillator to another using the modulation matrix. See *Modulation* on page 44 for more information.

Amplitude Modulation (AM): 0...127—(*In the OSC MODS tab in the OLED display*) As with FM, AM uses the oscillators as carrier/modulator pairs. But with AM, the modulator modulates the carrier's amplitude, not its frequency. As with FM, any oscillator routing combination can be configured using the modulation matrix.

Slop: 0...127—Adds random detuning to the oscillator to emulate the tuning instability of voltage controlled analog oscillators, from subtle, barely perceptible amounts to wildly out of tune.

Character

The Character controls affect the sonic character of the mixed output of the oscillators. The effect is dependent upon the frequency and harmonic content of the audio being processed. For example, Girth boosts and enhances low frequencies, so the effect upon high frequency content is minimal.

To access the Character controls, press the CHARACTER button in the Oscillator section.

Decimate	Drive	Hack	
0	0	0	
DECIMATE	DRIVE	HACK	
Sub Osc	Ext Input	Air/Girth	Char FX

Girth			Air
0			0
GIRTH			AIR
Sub Osc	Ext Input	Air/Girth	Char FX

Decimate: 0...127—Reduces the sample rate of the mixed output from the oscillators.

Drive: 0...127—Emulates tape saturation.

Hack: 0...127—Reduces the bit depth of the mixed output from the oscillators.

Girth: 0...127—(In the AIR/GIRTH tab in the OLED display) A low shelf filter to boost low frequencies, with some extra harmonic modification at higher settings.

Air: 0...127—(In the AIR/GIRTH tab in the OLED display) A high shelf filter to boost high frequencies, with some extra harmonic modification at higher settings.

Filter 1 & 2



Filters take the basic, raw sound of the oscillators and subtract frequencies, changing the harmonic content and thereby the character of the sound. This change can be varied over time using a *filter envelope* to produce more dynamic, animated timbres. The Pro 2's two-filter architecture allows for a wide range of sonic possibilities and is one of its most exciting features. Filter 1 is a 4-pole, 24 dB per-octave, analog resonant low-pass filter. Filter 2 is a 2-pole, 12 dB per octave, analog state-variable filter with low-pass, notch, high-pass, and band-pass modes.

The two filters can operate in series or in parallel with the FILTER ROUTING knob providing a variable mix of both modes. Used in series, audio is passed first through Filter 1 then Filter 2. Used in parallel, audio is passed simultaneously through each filter individually.

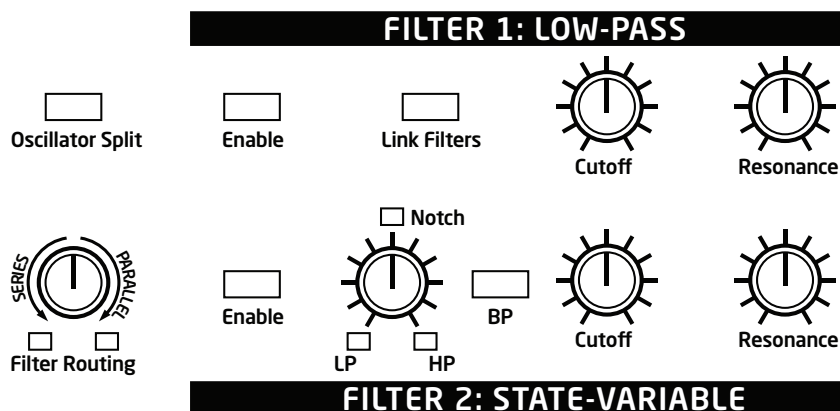
For even more processing flexibility, the OSCILLATOR SPLIT switch allows you to send oscillators 1 & 2 to Filter 1 and oscillators 3 & 4 to Filter 2.



In addition to the front panel controls for each filter, there are also several parameters accessible through the OLED display.

Ser/Par Mix	Filter Route	Notch/BP	LP <-> HP
Freq: 34 Res: 89			Freq: 164 Res: 41 N/BP: 0 LP/HP: 0
Filter Route	Filter 1	Filter 2	

F1 Freq	Resonance	Boost	KEY> F1 Freq
120 F1 FREQ	0 RESONANCE	0 BOOST	0 KEY > F1 FREQ
Filter Route	Filter 1	Filter 2	

F2 Freq	Resonance	LP <-> HP	Key> F2 Freq
120 F2 FREQ	41 RESONANCE	0 LP <-> HP	0 KEY > F2 FREQ
Filter Route	Filter 1	Filter 2	

Enable—Enables the chosen filter. Pressing both buttons at the same time enables both filters. When both are enabled, the FILTER ROUTING knob allows you to choose whether the filters operate in series, in parallel, or a variable mix of both.

Link Filters—When enabled, adjusting the front-panel FREQUENCY or RESONANCE controls of either filter will apply the settings to both. This button also links both filter envelopes and their amounts.

Frequency: 0...164—Sets the filter’s cutoff frequency. On Filter 1, frequencies below the cutoff pass through unaffected, hence the name “low-pass.” On Filter 2, the cutoff frequency operates as follows:

- Low-pass: passes frequencies below the cutoff frequency
- Notch: removes frequencies in a notch centered around the cutoff frequency.
- High-pass: passes frequencies above the cutoff frequency
- Bandpass: passes a band of frequencies centered around the cutoff frequency

Resonance: 0...127—Emphasizes a narrow band of frequencies around the cutoff frequency. On Filter 1, high levels of resonance can cause the filter to self oscillate.

Filter 2 does not self oscillate at the maximum resonance setting.

Filter Mode: LP, Notch, HP, BP—This knob selects Filter 2’s mode of operation. It transitions smoothly from low-pass to notch to high-pass operation, allowing a blending of these modes. Band-pass operation is selected with the BP switch. Each filter mode has its own characteristic sound and function. As noted previously:

- Low-pass: passes frequencies below the cutoff frequency
- Notch: removes frequencies in a notch centered around the cutoff frequency
- High-pass: passes frequencies above the cutoff frequency
- Bandpass: passes a band of frequencies centered around the cutoff frequency



On the front panel, band-pass mode is selectable only through the BP on/off switch. However, you can actually smoothly transition between normal and band-pass operation by choosing F2-NORMAL-BP as a modulation destination in the mod matrix.

Filter Routing: Series, Parallel—This knob selects a variable blend of serial or parallel processing by Filters 1 and 2. In series, audio is passed first through Filter 1 then Filter 2. In parallel, audio is passed simultaneously through each filter individually.

Oscillator Split: Off, On—When enabled, this switch sends oscillators 1 & 2 to Filter 1 and oscillators 3 & 4 to Filter 2.

Boost: 0...127—(*In the FILTER 1 tab of the display*) This boosts the output of Filter 1, making it possible to add makeup gain to the post-filter signal level or even overdrive the filter output and add harmonic distortion.

Key Amount: 0...127—(*In the FILTER 1 and FILTER 2 tabs of the display*) Sets the amount of modulation from the keyboard to the filter’s cutoff frequency. In simple terms, setting a value here means that the higher the note played on the keyboard, the more the filter opens. This is useful for adding “brightness” to a sound as higher notes are played, which is typically how acoustic instruments behave. A setting of 64 will step the filter in semi-tone increments for each note, 32 would be quartertones, and so on.

Filter Envelopes 1 & 2

Each of the Pro 2's two filters has its own dedicated, five-stage envelope generator. A filter envelope is used to shape how a sound's timbre or harmonic content changes over time during its attack, decay, sustain, and release stages. The Pro 2's filter envelopes provide additional controls for looping the envelope and for modulating the envelope amount using keyboard velocity.

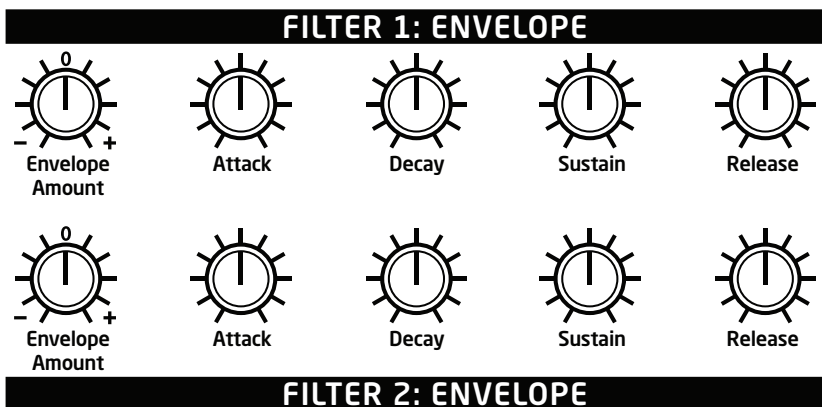

In addition to the front panel controls for each filter, there are also several parameters accessible through the OLED display.

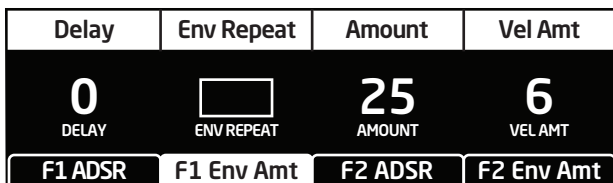
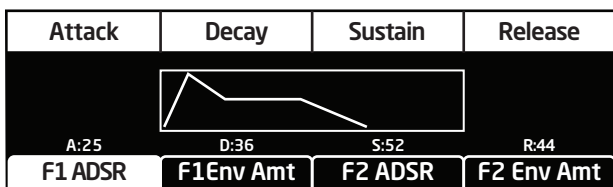

Delay: 0...127— (In the *F1* AMT and *F2* AMT tabs of the display) Sets a delay between the time the envelope is gated on and when the Attack segment actually begins.

Attack: 0...127—Sets the attack time of the envelope.

Decay: 0...127—Sets the decay time of the envelope.

Sustain: 0...127—Sets the sustain level of the envelope.

Release: 0...127—Sets the release time of the envelope.

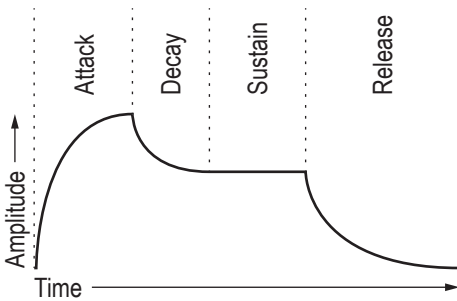

Env Repeat: Off, On—When on, the Delay, Attack, and Decay segments of the envelope repeat. Sustain still affects the level at which the Decay segment ends, but instead of sustaining at a fixed level while a note is gated on, Delay, Attack, and Decay loop until the note is turned off. The Release segment begins when the note is gated off, just as it does when Repeat is off. See the illustration below.

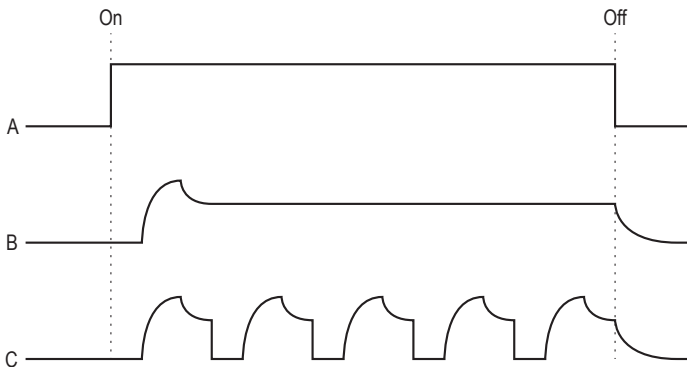

A: The gate generated by pressing, holding, and then releasing a key (or through use of the sequencer or arpeggiator).

B: Corresponding DADSR envelope behavior with Delay on and Repeat off.

C: Behavior of the same envelope with Repeat on.

Amount: -127...127—(*In the ENV AMOUNT tab in the display*) Sets the amount of modulation from the filter envelope to the filter frequency. The modulation amount can be positive or negative, allowing for inverted envelope control.



The cutoff frequency setting may limit the effect of the envelope on the filter. For example, on Filter 1, if FREQUENCY is all the way up, a positive envelope amount will have no effect on the filter since the filter is already completely open.

Velocity Amount: 0...127—(*In the ENV AMOUNT tab in the display*)

Enables keyboard velocity to modulate the FILTER ENVELOPE AMOUNT. It doesn't use keyboard velocity to directly control the filter cutoff. To do this, see the note below.



To create a program in which velocity controls the filter cutoff, turn filter envelope AMOUNT down and turn VELOCITY AMOUNT up. To achieve the best results, it may be necessary to set an initial level using Envelope Amount. Just remember that once Envelope Amount is set to the maximum, no modulation from velocity—or any other source—will cause the filter to go higher than that.

Amplifier Envelope

After passing through the filters and their envelopes, the signal goes into an analog voltage controlled amplifier or VCA. The VCA has a dedicated, five-stage envelope generator.

The Amplifier Envelope is used to shape the volume characteristics of a sound over time by giving you control over its attack, decay, sustain, and release stages. The Pro 2's envelope generators provide additional controls for looping the envelope and for modulating the envelope amount using keyboard velocity.

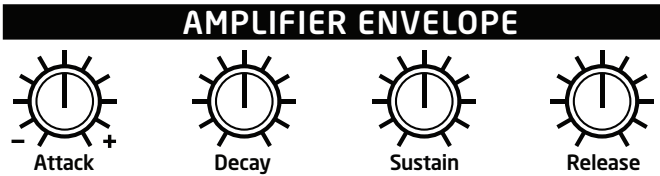

In addition to the front panel controls for the amplifier envelope, there are also several parameters accessible through the OLED display

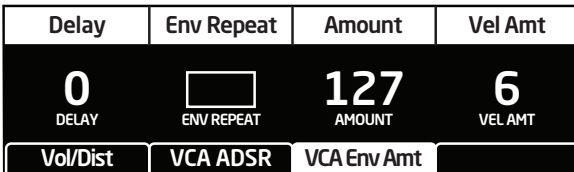
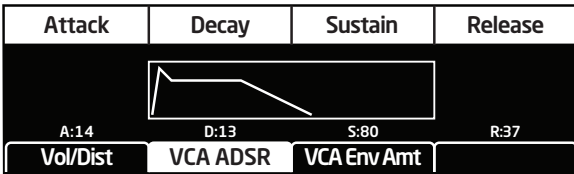
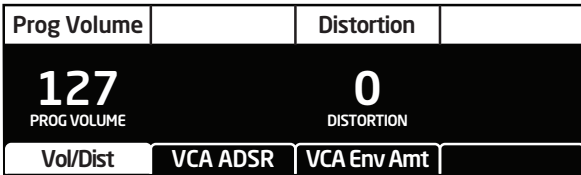

Delay: 0...127—(In the *VCA ENV AMOUNT* tab of the display) Sets a delay between the time the envelope is gated on and when the Attack segment actually begins.

Attack: 0...127—Sets the attack time of the envelope.

Decay: 0...127—Sets the decay time of the envelope.

Sustain: 0...127—Sets the sustain level of the envelope.

Release: 0...127—Sets the release time of the envelope.

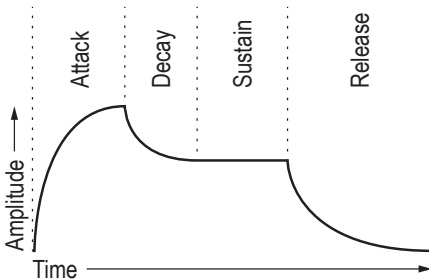

Volume: 0...127—(In the *VOL/DIST* tab of the display) Sets the volume of the current program. This control is particularly useful for ensuring that your sounds have roughly the same volume.



There is enough gain in the Pro 2's voice architecture that, with some settings, some mild clipping distortion may be heard. If this happens, try lowering the **VOLUME**, and/or the **VCA ENVELOPE AMOUNT** (or **VELOCITY AMOUNT**).

(VCA Envelope) Amount: 0...127—(In the *VCA ENV AMOUNT* tab of the display) Sets the amount of modulation from the amplifier envelope to the VCA. See **VELOCITY AMOUNT**, for information about setting a program's velocity sensitivity.

Velocity Amount: 0...127—(In the *VCA ENV AMOUNT* tab of the display) This enables keyboard velocity to modulate the VCA Envelope Amount. It doesn't enable keyboard velocity to directly control the VCA. To do this, see the note that follows.



To create a program in which velocity controls the VCA, turn `VCA ENVELOPE AMOUNT` down and turn `VELOCITY AMOUNT` up. To achieve the best results, it may be necessary to set an initial level using `Envelope Amount`. Just remember that once `Envelope Amount` is set to the maximum, no modulation from velocity—or any other source—will cause it to go higher than that.

Env Repeat: Off, On—(In the `VCA ENV AMOUNT` tab of the display)

When on, the Delay, Attack, and Decay segments of the envelope repeat. Sustain still affects the level at which the Decay segment ends, but instead of sustaining at a fixed level while a note is gated on, Delay, Attack, and Decay loop until the note is turned off. The Release segment begins when the note is gated off, just as it does when Repeat is off. See the illustration below.

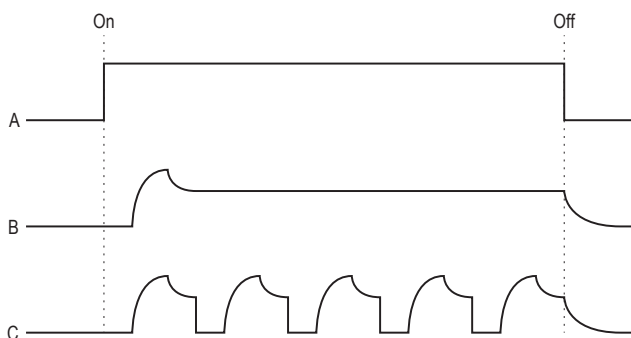

- A: The gate generated by pressing, holding, and then releasing a key.
- B: Corresponding DADSR envelope behavior with Delay on and Repeat off.
- C: Behavior of the same envelope with Repeat on.

Distortion: 0...127—(In the `VOL/DIST` tab of the display) Sets the amount of analog distortion applied to a program.

Auxiliary Envelopes 4 & 5

The Pro 2 has two additional five-stage envelope generators. They are useful for creating modulation that varies over time according to the shape of the envelope. Routing an envelope to an oscillator’s frequency, for example, causes the oscillator’s pitch to rise and fall according to the contour of the envelope.

As with all of the Pro 2’s envelopes, there are controls for looping the envelope and for modulating the envelope amount using keyboard velocity. Auxiliary envelopes 4 and 5 can be routed to any of the modulation destinations.



Actually, any of the Pro 2’s five envelopes can be routed to any destination (or multiple destinations) using the modulation matrix. See *Modulation* on page 44 for more information.

Controls for the auxiliary envelopes are found in the OLED display. To access them, press the ENV 4 or ENV 5 switch.



Env 4



Env 5

AUX ENV

Destination			
Osc 1 Shape Mod			
DESTINATION			
Aux Dest	Aux ADSR	Aux Env Amt	

Attack	Decay	Sustain	Release
A:25	D:36	S:52	R:44
Aux Dest	Aux ADSR	Aux Env Amt	

Delay	Env Repeat	Amount	Vel Amt
0 DELAY	<input type="checkbox"/> ENV REPEAT	127 AMOUNT	6 VEL AMT
Aux Dest	Aux ADSR	Aux Env Amt	

Destination—(In the *AUX DEST* tab of the display) Selects the parameter to be modulated by the envelope. See *Modulation Destinations* on page 81 for a list of possible destinations.

Delay: 0...127—(In the *AUX ENV AMT* tab of the display) Sets a delay between the time the envelope is gated on and when the Attack portion actually begins.

Attack: 0...127—(In the *AUX ADSR* tab of the display) Sets the attack time of the envelope.

Decay: 0...127—(In the *AUX ADSR* tab of the display) Sets the decay time of the envelope.

Sustain: 0...127—(In the *AUX ADSR* tab of the display) Sets the sustain level of the envelope.

Release: 0...127—(In the *AUX ADSR* tab of the display) Sets the release time of the envelope.

Env Repeat: Off, On—(In the *AUX ENV AMOUNT* tab of the display) When on, the Delay, Attack, and Decay segments of the envelope repeat. Sustain still affects the level at which the Decay segment ends, but instead of sustaining at a fixed level while a note is gated on, Delay, Attack, and Decay loop until the note is turned off. The Release segment begins when the note is gated off, just as it does when Repeat is off.

Amount: -127...127—(In the *AUX ENV AMOUNT* tab of the display) Sets the amount of modulation from the envelope to the chosen destination. The modulation amount can be positive or negative, allowing for inverted envelope control.

Velocity Amount: 0...127—(In the *AUX ENV AMOUNT* tab of the display) This enables keyboard velocity to modulate the Envelope Amount. It doesn't enable keyboard velocity to directly control the modulation. To do this, see the user tip that follows



To create a program in which velocity controls modulation amount, turn AUX ENVELOPE AMOUNT down and turn VELOCITY AMOUNT up.

Feedback

Feedback sends the analog output of the VCA to a tuned delay, whose output is mixed with the oscillators and input to the CHARACTER effects. By using varying degrees of feedback you can produce a range of effects ranging from slightly metallic to downright nasty.



Feedback Amt



Tuning

FEEDBACK

Feedback Amount: -127...0...127—Sets the level of feedback. As the level goes up, the feedback will eventually oscillate at the set Tuning. Medium levels of feedback add depth and movement to the sound. Negative values invert the signal producing different results than positive values.



Be careful when using feedback and filter settings with high resonance. Things can get loud quickly!

Tuning: 0...48—Sets the base frequency of the feedback loop. It steps in semitones from C0 to C4 for a four-octave range. The frequency always tracks the keyboard. The exact frequency is influenced by other factors, such as the filter frequency and filter type, which can drive it slightly sharp or flat.



You can modulate feedback tuning by routing a source such as NOTE NUMBER to FEEDBACK TUNING in the mod matrix.

Delay

The Pro 2 has four digital delays with panning. Delays 1-3 are standard digital multi-tap delays. Delay 4 emulates an analog, bucket-brigade device (BBD) delay.

Each of the delays can be used for simple delays or, with modulation and short delay times, flanging and chorus effects. Simple reverbs can also be created using different delay times, levels, and feedback amounts on each of the delays. Use each delay's low-pass or high-pass filter to simulate tape echoes. Delay times can be synced to the arpeggiator, sequencer, or MIDI clock.



To edit the same parameter on all 4 delays simultaneously, press and briefly hold one of the delay selector buttons and turn one of the dedicated knobs (TIME, AMOUNT, or FEEDBACK). In this state, you can also use the soft knobs in the display to edit the same parameter on each delay. To exit, press any of the delay selector buttons.

DELAY

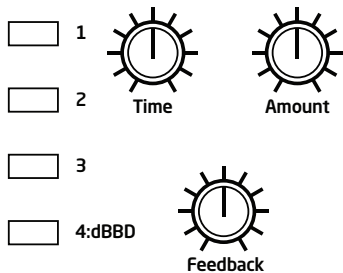

Delay Time	Sync	Amount	Feedback
30 DELAY TIME	<input type="text"/>	25 AMOUNT	6 FEEDBACK
Delay Time	Delay Filter		

LPF Freq	HPF Freq	Pan	Buffer Length
127 LPF FREQ	0 HPF FREQ	0 PAN	Long BUFFER LENGTH
Delay Time	Delay Filter		

The outputs of the delays are mixed back in with the Pro 2's left and right channels, so the primary audio path from the filters forward is entirely analog.

Delay Time: 0...255—Sets the delay time for the selected tap, from a minimum of 0.9556 milliseconds to a maximum of 1 second. For a complete list of the available delay times, see *Delay Times* on page 84

Amount: 0...127—Sets the level of the delayed signal. At 0, the delay is off.

Feedback: 0...127—Sets the amount of feedback from the selected delay tap to the input of the delay.

Sync: Off, On—(*In the DELAY TIME tab in the display*) Sets the delay time to a subdivision or multiple of the BPM setting. This allows the delay to be synced to the arpeggiator, sequencer, or MIDI clock. The sync settings are all based upon one beat equals one quarter note.

When Sync is on, Delay Time provides the following values.

Displayed Value	Delay Time
64th	1/16 of 1 beat
32nd	1/8 of 1 beat
32nd Dot	3/16 of 1 beat
16th	1/4 of 1 beat
16th Dot	3/8 of 1 beat
8th	1/2 of 1 beat
8th Dot	3/4 of 1 beat
Qrtr	1 beat
Qrtr Dot	1 1/2 beat
Half	2 beats
Half Dot	3 beats
Whole	4 beats



Maximum delay time is 1 second. The combination of longer synced delay times with slower tempos can result in delay times that would be greater than 1 second. When that happens, the delay time is divided by 2 until it no longer exceeds the 1 second limit. For example, if the BPM is set to 60 and Delay Time is set to Half, the expected delay time would be 2 seconds. The actual delay time will be 1 second (i.e. 2 seconds divided by 2).

LP Freq: 0...127—(In the *DELAY FILTER* tab in the display) Sets the cutoff frequency of the low-pass filter in the feedback path. A low-pass setting of 127 results in no filtering. Use the low-pass filter to create natural-sounding echoes and analog tape echo effects.

HP Freq: 0...127—(In the *DELAY FILTER* tab in the display) Sets the cutoff frequency of the high-pass filter in the feedback path. A high-pass filter setting of 127 equals maximum filtering. Use the highpass filter to create interesting flange effects and unnatural sounding echoes.

Pan: -64...+63—(In the *DELAY FILTER* tab in the display) Allows you to pan the output of a delay anywhere in the stereo field. This is very useful in creating a rich stereo image as well as for ping-pong echo effects.



Delay Pan is also a modulation destination. That is, the stereo pan position of the delayed signal can be modulated using an LFO or any mod source in the modulation matrix. Use this to create auto-panning effects.

Buffer Length: Long, Short— (In the *DELAY FILTER* tab of *Delay 4* only) Choose Short, for shorter delays, chorus, or flange type effects. Choose Long for longer repeat delays and when modulating delay times for analog delay-style detuning effects.

Creating Reverb and Modulation-Based Effects

As previously noted, you can use the Pro 2's delays to create not only simple delays but also flanging and chorus effects, and simple reverbs.

Reverb

A reverb is effectively multiple delays of a source signal as it moves through a space and bounces off of various surfaces. You can simulate small to medium sized rooms, spring, and plate reverb effects by using the four delay paths, feedback paths, and amounts. Try setting each of the delay times to different time settings between 30 and 70. Set the amounts and feedbacks to different values and listen to how the sound changes. Altering the values of the above parameters will “sculpt” the sound of the reverberation.



For best results when creating reverb effects, use a short buffer length and shorter delay times with Delay 4.

Flanging and Chorus

The delay time can be modulated to produce flanging and chorus effects. The main difference between the two is that flanging uses feedback and chorus does not, and chorus typically uses a longer delay time (though, with modulation, the range of delay times for each effect may actually overlap a bit).

For flanging, a Time value of 31 (4.8157 milliseconds) or less is a good place to start. Use a triangle wave LFO to modulate the delay time, being careful to keep the LFO Amount low so that it doesn't drive the delay time to zero and "flatten out" the triangle at one extreme. It will be fairly obvious when that happens.

For chorus, start with a value around 53 (17.164 milliseconds).

Ping-Pong Echo

For ping-pong effects, use a square LFO routed to Delay Pan. Some amount of DC routed to Delay Pan (in the modulation matrix) will place the ping-pong in the desired position in the stereo field. Both the LFO and the Delay must have Sync on, and the LFO should also have Wave Reset on, to keep everything in sync.

Low Frequency Oscillators

LFOs are special-purpose oscillators that produce frequencies below the range of human hearing. LFOs are typically used for periodic modulation or changes in sound such as vibrato (periodic pitch modulation) and tremolo (periodic volume modulation).

The Pro 2 provides four LFOs that produce a variety of waveshapes. Although they're classified as low-frequency modulation devices, they can actually function at speeds that extend into the audible range for extreme modulation effects. The LFOs can be free-running, reset by keystrokes, or synced to the arpeggiator, sequencer, or MIDI clock.



Press any of the four LFO buttons to choose an LFO for editing.

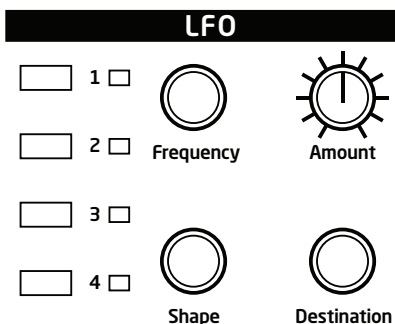

To edit the same parameter on all 4 LFOs simultaneously, press and briefly hold one of the LFO selector buttons and turn one of the dedicated knobs (FREQUENCY, AMOUNT, SHAPE OR DESTINATION). In this state, you can also use the soft knobs in the OLED display to individually edit the same parameter on each LFO. To exit this mode, press any of the LFO selector buttons.



In addition to the front panel controls for each LFO, additional parameters are accessible through the OLED display.

Shape	Frequency	Sync	Amount
 Triangle	40 Frequency	 SYNC	6 AMOUNT
LFO Shape	LFO Control	LFO Dest	

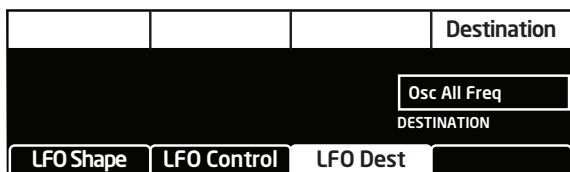
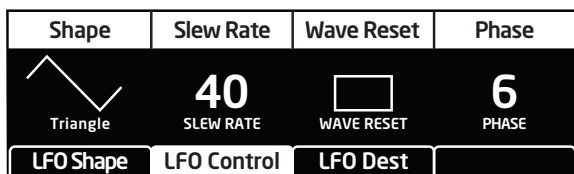

Frequency: 0...127—Sets the frequency of LFO modulation routed to the selected destination. See also “Sync.”

Amount: 0...127—Sets the amount of LFO modulation routed to the selected destination.

Destination—Selects the parameter to be modulated by the LFO. See *Modulation Destinations* on page 81 for a list of possible destinations.

Shape: Triangle, Reverse Sawtooth, Sawtooth, Square, Pulse 1, Pulse 2, Pulse 3, Random—The wave shape of the LFO.

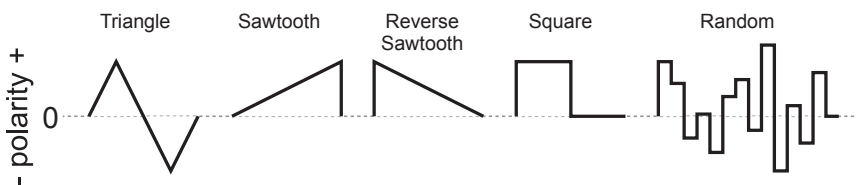

Random, also known as “sample and hold,” generates a series of random values, each held for the duration of one cycle.

Triangle is bipolar. That is, it is positive for half its cycle and negative for the other half. That makes it possible to generate a natural-sounding vibrato that goes alternately sharp and flat in equal amounts on either side of a center frequency. The other wave shapes and Random generate only positive values. However, any of the LFOs can be inverted by specifying negative MODULATION AMOUNT values (e.g. -127, -64, etc.) in the modulation matrix.

Sync: Off, On—When on, Frequency displays note values that sync precisely with the arpeggiator, sequencer, and delay.

Displayed Value	Cycle Duration
32nd Trip	1/12 of 1 beat
32nd	1/8 of 1 beat
16th Trip	1/6 of 1 beat
16th	1/4 of 1 beat
8th Trip	1/3 of 1 beat
8th	1/2 of 1 beat
Qrtr Trip	1 1/3 beats
1 Qrtr	1 beat
Qrtr Dot	1 1/2 beats
1/2 Note	2 beats
3 Qrtr	3 beats
4 Qrtr	4 beats
6 Qrtr	6 beats
8 Qrtr	8 beats
16 Qrtr	16 beats
32 Qrtr	32 beats

Slew Rate: 0...127—(In the LFO CONTROL tab in the display) Slew rate is defined as the maximum possible rate of change of a signal. The effect of the Slew Rate control is most obviously heard on Pulse and Random, shapes that normally change state virtually instantaneously. As Slew Rate increases, those changes are drawn out, elongated, and the result is a sort of smoothing effect.

Wave Reset: Off, On—(In the LFO CONTROL tab in the display) When off, the LFO is free running. When on, the LFO is re-started each time a new note is played. WAVE RESET is set independently for each LFO.

Phase: 0...127—(In the LFO CONTROL tab in the display) Used in conjunction with Wave Reset, Phase sets the initial phase, from 0 to 360 degrees, at which the LFO wave shape starts when keyed on. Each step represents 2.8125°, so a value of 32 equals 90°, 64 equals 180°, and so on.



Use Phase to offset the start point when Wave Reset is on. For Phase to have any noticeable effect, Wave Reset must also be turned on for that LFO. If the LFO is free-running—that is, with Wave Reset off—there is no fixed start point from which the phase can be offset.

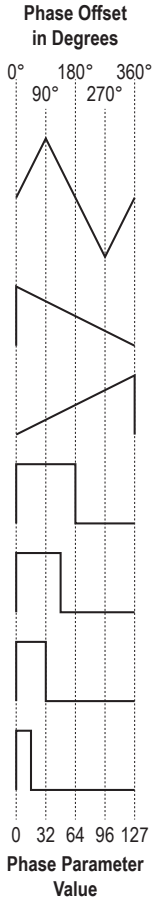

Modulation

Although the sonic character of the Pro 2 is largely determined by its oscillators and filters, its power to make truly unique sounds comes from its extensive modulation capabilities. The Pro 2 has 25 fixed-source modulation paths and 16 user-configurable paths with over 50 different modulation sources and over 140 different destinations. This makes the Pro 2's modulation matrix as powerful as many modular synths. For a complete list of modulation sources and destinations, see page 80.

Think of a modulation slot as a virtual patch cable that lets you connect any modulation source (envelope, sequencer, LFO, etc.) to any modulation destination (filter cutoff, pulse width, delay time, etc.). You can also control how much the source affects the destination by specifying the modulation amount.

To display the modulation matrix, press the **ASSIGN SOURCE** or **ASSIGN DEST** buttons in the Modulation section. Modulations slots and routings appear in the OLED display.

MOD



Assign Source



Assign Dest



Amount

Edit Mod 1	Source	Amount	Destination
Mod 1	Slider 1 Position	▶ 60 ▶	F1 Cutoff
Mod 2	Slider 2 Position	▶ 35 ▶	F1 Resonance
Mod 3	Aftertouch	▶ 25 ▶	Drive
Mod4	Mod Wheel	▶ 80 ▶	Sub Osc Level
Slot Sort	Sort Source	Sort Dest	

Edit Mod #: (*Soft knob 1 in the display*) Selects a modulation slot.

Source: (*Soft knob 2 in the display*) Selects a modulation source.

Amount: (*Soft knob 3 in the display*) Sets the amount of modulation from the source to the destination. Amount can be set over a range of -127 to 127.

Destination: (*Soft knob 4 in the display*) Selects the modulation destination.

Sort Slot: (*Soft key 1 in the display*) Sorts all mod slots in numerical order.

Sort Source: (*Soft key 2 in the display*) Sorts all mod sources by similar type. This makes it easier to see when the same source is routed to multiple destinations.

Sort Destination: (*Soft key 3 in the display*) Sorts all mod destinations by similar type. This makes it easier to see when the same destination is receiving modulation from multiple sources.

Using the Assign Mod Buttons

The Pro 2 provides a shortcut for modulation routing using the Assign Mod Source and Assign Mod Destination buttons.

To quickly assign modulation:

1. Press and hold the `ASSIGN MOD SOURCE` button. Choose a source by turning its knob or pressing its button, or by using a controller (pitch wheel, mod wheel, or touch slider). The mod matrix appears in the display and the source is assigned to the first available mod slot. Release the `ASSIGN MOD SOURCE` button when done.
2. Press and hold the `ASSIGN MOD DESTINATION` button. Choose a destination by turning its knob or pressing its button. That destination is assigned to the mod slot. Release the `ASSIGN MOD DESTINATION` button when done.
3. Use either the `AMOUNT` knob or soft knob 3 to set the modulation amount.



To quickly choose a Character effect as a mode destination, hold down the `ASSIGN MOD DESTINATION` button then tap the `CHARACTER` button repeatedly to cycle through the various character parameters.

Arpeggiator

The Pro 2 has a flexible and full-featured arpeggiator that can be synced to the LFOs, delays, or external MIDI clock.

To access the arpeggiator functions, press the ARPEGGIATOR switch. The arpeggiator is activated and its parameters appear in the OLED display. Hold down one or more notes on the keyboard and the arpeggiator plays them according to the settings specified in the display.

Arp Mode	Octave Range	Arp Auto Latch	Repeats
Up+Down ARP MODE	1 Octave OCTAVE RANGE	<input type="checkbox"/> ARP AUTO LATCH	0 REPEATS
Seq+Arp	Seq	Arp	Seq Misc

BPM	Clock Divide		
120 BPM	1/16 CLOCK DIVIDE		
Seq+Arp	Seq	Arp	Seq Misc

Arpeggiator Switch—Turns the Arpeggiator on and off.

Arp Mode: Sets the order in which notes play when Arpeggiator is on. See the table below.

Arp Mode	Behavior
Up	Plays from lowest to highest note
Down	Plays from highest to lowest note
Up + Down	Plays from lowest to highest and back to lowest
Assign	Plays notes in the order the keys were pressed
Random	Plays notes randomly

Octave Range: 1 Octave, 2 Octaves, 3 Octaves—Set to 1 Octave, only the keyed notes are arpeggiated. Set to 2 Octaves, the keyed notes and the notes one octave above them arpeggiate. Set to 3 Octaves, the keyed notes and the notes one and two octaves above them arpeggiate.

Arp Auto Latch: Off, On—Works in conjunction with HOLD. When HOLD and ARPEGGIATOR are on and ARP AUTO LATCH is off, played notes are held on and arpeggiated, with additional played notes added to the held notes and the arpeggio.

When ARP AUTO LATCH and the HOLD switch are both on, played notes are latched on. Removing your hands from all keys and then playing an additional note or notes causes the held notes to be released and the newly played note(s) to be latched on. As long as at least one key is held, pressing additional keys will add to the arpeggio.

Repeats: 0...3—Set to 0, each note in the arpeggio plays once. Set to 1, each note in the arpeggio plays once and then repeats once, which is a long way of saying each step plays twice. The maximum number of repeats is 3 (each step plays four times).

BPM: 30...250—Sets the tempo for the arpeggiator in BPM (beats per minute). The TAP TEMPO LED flashes at the BPM rate. When Sync is turned on for an LFO or Delay, the BPM rate affects its LFO frequency or delay time. When syncing to an external MIDI clock source, the BPM setting has no effect.

Tap Tempo—Tapping the TAP TEMPO button sets the tempo from 30 to 250 BPM. The LED flashes at the BPM rate you set. For best results, tap the button 4 times.

Clock Divide: See table—Sets the note value for each arpeggiator step relative to the BPM. CLOCK DIVIDE works with both internal and external clock sources. The following table lists the CLOCK DIVIDE values.

Display	Tempo	Timing Division
1/2	BPM/2	Half note
1/4	BPM	Quarter note
1/8	BPM x 2	Eighth note
1/8 Half Swing	BPM x 2	Eighth note, half swing timing
1/8 Full Swing	BPM x 2	Eighth note, full swing timing
1/8 Triplet	BPM x 3	Eighth note triplets
1/16	BPM x 4	Sixteenth note
1/16 Half Swing	BPM x 4	Sixteenth note, half swing timing
1/16 Full Swing	BPM x 4	Sixteenth note, full swing timing
1/16 Triplet	BPM x 6	Sixteenth note triplets
1/32	BPM x 8	Thirty-second note

To play the arpeggiator:

1. Press the ARPEGGIATOR button.
2. Hold down a chord on the keyboard. The arpeggiator plays the notes according to the settings specified in the display.
3. Adjust settings such as ARP MODE, OCTAVE RANGE, REPEATS, BPM and CLOCK DIVIDE.
4. To synchronize a delay to the arpeggiator, turn on SYNC for that delay and adjust its DELAY TIME setting as desired.

Sequencer

For many musicians, the term sequencer has become synonymous with MIDI sequencer—a software application for recording and playing back MIDI performance data. But sequencers were around long before MIDI.

The original sequencers in modular synths were used as a modulation source. They produced a series of control voltage events at timed intervals that could be used to change the value of a synth parameter in discrete steps. Sequences could be routed to oscillator frequency to produce a series of pitched notes, to filter frequency to produce stepped filtering effects, and so on.

The Pro 2's sequencer is like an original analog sequencer but more powerful. It provides either sixteen tracks of 16-step sequences, or eight tracks of 32-step sequences—depending on which mode you choose for a particular program. Each sequencer track can be routed to a different modulation destination, and each step in a sequence can be set to a different value to modulate that destination.

The Pro 2's sequencer also allows rests, ties, and sequences of variable length, all of which make for some very interesting and complex patterns, particularly when sequences are set to a mixture of odd and even numbers of steps.

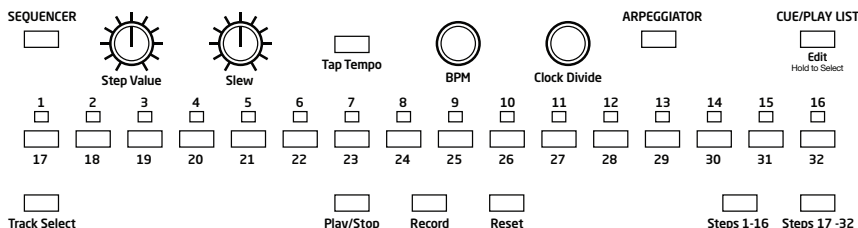

	Note: C5					Vel: 100					Slew: 0					Tie				
Notes	C	C	C	C	C	C	C	C	C	C	C	C	C	C	C	C	C	C	C	C
Slew																				
Velocity																				

Programming the Sequencer

Rather than describe all of the sequencer's parameters up front, it's more useful and a lot more fun to simply walk through how to program a basic sequence. You can read about the various parameters afterward.

By default, Track 1 of the sequencer always controls oscillator frequency, meaning that it's effectively hard-wired for recording notes. Beyond that, any sequencer track can be routed to any modulation destination. A typical scenario might have Track 2 routed to filter cutoff, Track 3 routed to filter resonance, and Track 4 routed to amplifier envelope amount or the VCA for accents.



Many of the factory programs have sequences associated with them. You may want to analyze these to see how certain effects were achieved so you can use them in your own sequences.

To program a note sequence:

1. Select a program with a relatively sharp attack and short release.
2. Press the **SEQUENCER** button to turn on the sequencer.
3. Press soft key 4 to select the **SEQ MISC** tab.
4. Turn soft knob 2 (**LENGTH**) and select either **16x16** or **8x32**.



16x16 allows sequences of up to 16 steps on up to 16 individual sequencer tracks. **8x32** allows sequences of up to 32 steps on up to 8 individual sequencer tracks.

5. Press the **RECORD** button.
6. Play a series of notes on the keyboard. The numbered step LEDs indicate which step you're on.
7. If you make a mistake, toggle the **RECORD** button off, then on again, and replay the notes correctly.
8. If you want to record fewer than 16 steps, play only the notes you want.
9. When you're done inputting notes, press **PLAY/STOP**. Your sequence plays back. To stop playback, press **PLAY/STOP** again.



Use the **BPM**, **CLOCK DIVIDE**, or **TAP TEMPO** controls to adjust sequencer playback speed.



Hold down the **STEPS 1-16** button or **STEPS 17-32** button and press **RESET** to reset all tracks to the sequencer's max track length (16 or 32 depending on which button you press).



To transpose a sequence up or down, hold down a note on the keyboard above or below middle C. Middle C plays the sequence as recorded. For greater range, use the **Transpose Up** or **Transpose Down** buttons.

To record over an existing note sequence:

1. Make sure the **SEQUENCER** button is on.
2. If a sequence is running, press **PLAY/STOP** to stop it.
3. Press the **RECORD** button.
4. Play different notes on the keyboard. The numbered step LEDs indicate which step you're on.
5. When you're done, press **PLAY/STOP** to listen to the new sequence.

To erase an existing sequence:

1. Press and hold the **TRACK SELECT** button.
2. Turn soft knob 1 (**SELECT TRACK**) to select the desired sequencer track.
3. Press soft key 4 to execute the **CLEAR TRACK** command.
4. Release the **TRACK SELECT** button.

Recording Additional Sequencer Tracks for Modulation

Track 1 of the sequencer is permanently routed to the oscillators. But other sequencer tracks can be routed to any modulation destination. Here's how to sequence filter cutoff modulation on Track 2.

To modulate Filter 1 cutoff frequency using sequencer Track 2:

1. Press and hold the TRACK SELECT button then press sequencer step LED 2. (Alternatively, turn soft knob 1 (SELECT TRACK) to select track 2.)
2. While continuing to hold down the TRACK SELECT button, turn soft knob 4 (DEST) to select F1 FREQ.
3. Release the TRACK SELECT button.

At this point you can either start the sequencer running and record the modulation values in real time or input the values step by step with the sequencer stopped.



Holding down the TRACK SELECT button then pressing a numbered sequencer step LED (1-16) is a quick way to select a sequencer track for editing. Additionally, holding down the TRACK SELECT button then turning a front-panel parameter knob is a quick way to select a parameter to sequence.

To sequence Filter 1 cutoff in real time:

1. Press PLAY/STOP to start the sequencer running.
2. Press and hold the RECORD button.
3. As the sequencer cycles through its steps, turn the CUTOFF knob for Filter 1. Changes in cutoff frequency are recorded as individual steps on Track 2.
4. When you're done, release the RECORD button.
5. To stop playback, press PLAY/STOP again.



When you're recording parameter values in real time, be aware of where and when the sequence loops back around to its beginning or you might inadvertently overwrite some of your values.

To sequence *Filter 1 cutoff step-by-step*:

1. Make sure the **SEQUENCER** button is on.
2. If the sequencer track editor isn't already visible for Track 2, press and hold the **TRACK SELECT** button then press sequencer step LED 2.
3. To go to step 1 of the sequence, press and briefly hold step LED 1.
4. Turn soft knob 1 (**VALUE**), or turn the **STEP VALUE** knob, or turn the front-panel **Filter 1 CUTOFF** knob to set a value.
5. To go to step 2 of the sequence, press and briefly hold step LED 2.
6. Turn soft knob 1 (**VALUE**) or turn the **STEP VALUE** knob to set a value.
7. Repeat steps 5 and 6 for each step in the sequence until finished.
8. To trigger the sequence, press **PLAY/STOP**.



By default, sequencer tracks 2-16 conform to the length of sequencer track 1. To record a track of greater or lesser length, reset the track's sequence length by holding down the numbered sequencer step LED equal to the desired length of the sequence and pressing the **RESET** button. For a 12-step sequence, for example, hold down step LED #12 and press **RESET**.



If you are working with a 32-step sequence, use the **STEPS 1-16** and **STEPS 17-32** buttons to toggle between the two sets of steps.



To smooth the transition from step value to step value, use the **SLEW** knob (or soft knob 3) to set a **SLEW** amount for each step. More on slew later.

Adding Rests, Ties, and Velocity

When recording note sequences using the keyboard, the sequencer assigns each note that you play (along with its velocity) to the next successive step in the sequence. However, it's very useful to add rests, ties, and additional velocity changes for greater rhythmic variation so that things don't sound too robotic (unless that's your goal).

Adding Rests

Rests allow you to turn off a note in a sequence. You can add rests to an existing sequence, or if you're creating a sequence in step mode, you can add them as you go.



The quickest way to add a rest to an existing sequence is to turn off the front-panel LED button for that step. The step/button can be toggled on again if you want.

To add rests to an existing sequence using the sequence editor:

1. Hold down the **TRACK SELECT** button and press the step LED with the same number as the track you want to edit. Release the **TRACK SELECT** button.
2. Toggle off the LED for the step that you want to rest. (The step can be toggled on again if you want.)
3. Repeat for any additional steps/rests.
4. To listen to the sequence, make sure the **SEQUENCER** button is on, then press **PLAY/STOP**.



If you are working with a 32-step sequence, use the **STEPS 1-16** and **STEPS 17-32** buttons to toggle between the two sets of steps.

steps 3-4
have rests

	Note: C5		Vel: 96		Slew: 0						Tie				
Notes	C 5	C 5	*	*	C 5	C 5	C 5	C 5	C 5	C 5	C 5	C 5	C 5	C 5	C 5
Slew			*	*											
Velocity			*	*											
	Rest/Tie														

Adding Ties

Ties allow you to increase the duration of a note in a sequence (i.e. the number of steps that it's held). You can add ties to an existing sequence, or if you're creating a sequence in step mode, you can add them as you go.



Sequence step LEDs appear slightly dimmed on steps that are tied.

To add ties to an existing sequence:

1. Hold down the TRACK SELECT button and press the step LED with the same number as the track you want to edit. Release the TRACK SELECT button.
2. Press and continue to hold the LED button for the step where the tie will start.
3. Press the LED button for the step where the tie will end.
4. Release the buttons.
5. To create additional ties, repeat steps 1-4.

To add ties to an existing sequence using the sequence editor:

1. Hold down the TRACK SELECT button and press the step LED with the same number as the track you want to edit. Release the TRACK SELECT button.
2. Press and continue to hold the LED button for the step where the tie will start.
3. Turn soft knob 4 (TIE) and keep rotating to set the length (in steps) of the tie.
4. To add ties to other portions of the sequence, Toggle the desired step LED off and on, then turn soft knob 4 (TIE) to set the length of the tie.
5. Repeat steps 2-4 as desired.
6. To listen to the sequence, make sure the SEQUENCER button is on, then press PLAY/STOP.

steps 1-4
are tied

	Note: C5	Velo:100				Slew:0				Tie				
Notes	C 5	*	*	*	C 5	C 5	C 5	C 5	C 5	C 5	C 5	C 5	C 5	C 5
Slew														
Velocity														

Adding Velocity

When you use the keyboard to record note sequences in real time, the sequencer records note velocity along with the note values. It's easy, however, to edit the existing values to add more dynamics, or if you're creating a sequence in step mode, add them as you go.

To edit velocity on an existing sequence:

1. Hold down the **TRACK SELECT** button and press the step LED with the same number as the track you want to edit. Release the **TRACK SELECT** button.
2. Press and briefly hold the LED button for the step that you want to edit.
3. Turn soft knob 2 (**VEL**) to set the velocity of the step.
4. Repeat steps 2 and 3 as desired.
5. To listen to the sequence, make sure the **SEQUENCER** button is on, then press **PLAY/STOP**.



Velocity is only available for editing on Track 1 or Tracks that have (MIDI) Out 1 or Out 2 as their destination.



If you have a sequencer track assigned to a MIDI channel output and it is only sending MIDI note-off messages, check the value of the Velocity parameter for each step. A velocity greater than zero must be set for a MIDI note-on message to be sent. If the velocity for a given step is set to zero, only a MIDI note-off message will be sent for that step.

Sequencer Parameters

Here are the controls and parameters used when interacting with the sequencer.

Sequencer: On, Off—This switch turns the sequencer on and off. The sequencer must be on in order to play a sequence.

Step Value: C0...C10, -127...127—This knob selects a note or numerical value for the step and parameter being edited.

Slew: -127...127—Slew is used to create a smooth transition between successive, discrete control voltage levels. In the case of the sequencer you can use slew to create glide effects between note values, a smooth filter cutoff sweep, and so on, depending on the parameter being sequenced. Lower values create faster transitions.



Depending upon the BPM and Clock Divide settings, the slew rate can actually exceed the time the envelopes are gated on, causing a step in the affected sequence to not reach its set value. For example, if Slew is applied to note values or oscillator frequency, high Slew values may cause a step to sound flat or sharp. If that's not what you want, simply reduce the Slew value.

BPM: 30...250—Sets the tempo for the sequencer and arpeggiator in BPM (beats per minute). The TAP TEMPO LED flashes at the BPM rate. When Sync is turned on for an LFO or Delay, the BPM rate affects its LFO frequency or delay time. When syncing to an external MIDI clock source, the BPM setting has no effect.

Tap Tempo: 30...250—Tap this button two or more times to quickly set the tempo for the sequencer and arpeggiator. The LED flashes at the BPM rate you set. For best results, tap the button 4 times.

Clock Divide: Sets the note value for each arpeggiator step relative to the BPM. CLOCK DIVIDE works with both internal and external clock sources. The following table lists the CLOCK DIVIDE values.

Display	Tempo	Timing Division
1/2	BPM/2	Half note
1/4	BPM	Quarter note
1/8	BPM x 2	Eighth note
1/8 Half Swing	BPM x 2	Eighth note, half swing timing
1/8 Full Swing	BPM x 2	Eighth note, full swing timing
1/8 Triplet	BPM x 3	Eighth note triplets
1/16	BPM x 4	Sixteenth note
1/16 Half Swing	BPM x 4	Sixteenth note, half swing timing
1/16 Full Swing	BPM x 4	Sixteenth note, full swing timing
1/16 Triplet	BPM x 6	Sixteenth note triplets
1/32	BPM x 8	Thirty-second note

BPM: 30...250—Sets the tempo for the arpeggiator in BPM (beats per minute). Tap Tempo flashes on the beat. Also affects the LFO frequency

Step LEDs 1-16: These LEDs have a multiple purposes. First, they indicate the current sequencer step during playback. Second, by toggling an LED off, you can designate that step as a rest. When you hold down TRACK SELECT and press a numbered step button, they allow you to select the numerically corresponding sequencer track and show it in the display's sequence editor.

Track Select: When pressed in conjunction with the numerically corresponding sequencer step, this selects the numerically corresponding sequencer track and shows it in the display's sequence editor.

Play/Stop Button: Starts and stops sequencer playback when the sequencer's PLAY SOURCE is set to SEQUENCER.

Record Button: Engages and disengages sequencer recording.

Reset Button: Holding this button and pressing a numbered step LED marks that step as the end of a sequence. Pressing the RESET button during sequencer playback, jumps the sequence back to step 1 and continues playing.

Steps 1-16: This LED/button indicates which block of steps (1-16 or 17-32) is currently engaged in playback. When editing a 32-step sequence pressing this button toggles to steps 1-16.

Steps 17-32: This LED/button indicates which block of steps (1-16 or 17-32) is currently engaged in playback. When editing a 32-step sequence pressing this button toggles to steps 17-32.

Play Source: Sequencer, Key, Ext In, CV 1, CV2, CV3, CV4—(*In the SEQ tab in the display*) Selects the source that triggers the sequencer.



For optimal results when the sequencer's PLAY SOURCE is set to EXT IN, adjust the EXT IN LEVEL and THRESHOLD parameters as necessary. To access these parameters in the display, turn the EXT. INPUT LEVEL knob on the front panel of the Pro 2.

Play Mode: Normal, Step, Play Once—*(In the SEQ tab in the display)* Selects how the sequencer reacts when triggered. In NORMAL mode, when the sequencer is triggered, the sequence will play continuously until manually stopped. In STEP mode, the sequencer will advance step-by-step with each new trigger it receives. In PLAY ONCE mode, the sequencer will play the sequence through, one time only, when triggered.

Restart: Off, On—*(In the SEQ tab in the display)* Selects whether or not the sequence restarts from step 1 each time a trigger is received from any of the various gate sources (keyboard, external input, gate in, etc.).

Env Trig/Step: Off, On—*(In the SEQ tab in the display)* Selects whether or not the envelopes are triggered by each step of the sequence. If set to Off, the envelopes are triggered only by the initial sequence trigger.

Length: 16x16, 8x32—*(In the SEQ MISC tab in the display)* Selects the maximum length of the sequence.

Master Volume/Voice Volume

The master output level of the Pro 2 is controlled by the front-panel VOLUME knob. However, the volume of an individual program is set in the VOL/DIST tab of the VCA screen. To access this screen, turn the front-panel DISTORTION knob. The PROGRAM VOLUME control is particularly useful for ensuring that your sounds have roughly the same volume from program to program.



Volume



Distortion

Prog Volume		Distortion	
127		0	
PROG VOLUME		DISTORTION	
Vol/Dist	VCA ADSR	VCA Env Amt	

To set the volume of an individual program:

1. Turn the front-panel DISTORTION knob to show the PROG VOLUME (and DISTORTION) parameters in the display.
2. Use soft knob 1 (PROG VOLUME) to set the volume level of the current program.



MIDI volume can also influence the overall volume of the Pro 2 if you are controlling it from an external MIDI source.

Distortion

The Pro 2 features stereo analog distortion which can be used to add warmth, harmonic complexity, and even an aggressive edge to sounds. The character of the distortion is affected by the harmonic content of a program. Sounds with more high-end will sound different than sounds with fewer harmonics. To add distortion, use the front-panel DISTORTION knob or the VOL/DIST tab of the VCA screen. (To access this screen, turn any knob in the front-panel AMPLIFIER ENVELOPE section.)



Volume



Distortion

Distortion: 0...127—Sets the distortion amount.

Transpose

The up and down buttons in the transpose section transpose the keyboard up or down in octaves. The LED indicates the current keyboard transposition state. Transposing the keyboard also changes the MIDI note numbers of the keys so that MIDI notes sent are also transposed. Transpose settings are global and are not saved with individual programs.

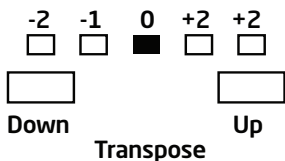

Glide

Glide or *portamento* causes the pitch of a note to glide up or down from the pitch of the previously played note. When played paraphonically, glide is disabled.

Glide is turned on and off using the GLIDE switch, but the GLIDE AMOUNT must also be set in the Oscillators section. If the GLIDE button is on, but GLIDE AMOUNT is set to 0 for all oscillators, GLIDE has no effect. GLIDE AMOUNT can be set to a different value for each of the oscillators.

LATORS

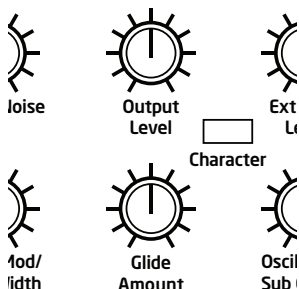

Glide Mode	Retrigger	Gate Source	Key Assign
FixTimeA	On	Keyboard	Low Note
GLIDE MODE	RETRIGGER	GATE SOURCE	KEY ASSIGN
Key Modes	Pitch Wheel		



To set GLIDE AMOUNT for all four oscillators simultaneously, press and briefly hold any of the oscillator select buttons until all four buttons light. GLIDE AMOUNT now controls all four oscillators. Press any of the oscillator select buttons to de-select the other oscillators.

In addition to GLIDE AMOUNT, there are four Glide modes—FixRate, FixRate A, FixTime, and FixTime A—that determine how GLIDE behaves. Turn GLIDE on to display and change the modes.

FixRate: The time to transition between notes varies with the interval between the notes; the greater the interval, the longer the transition time. The glide rate is fixed.

FixRate A: The same as FixRate, but glide is only applied when playing legato. That is, glide only occurs when a note is held until the next note is played. This effectively allows glide to be turned on and off from the keyboard.

FixTime: Glide is set to a fixed time, regardless of the interval between notes.

FixTime A: The same as FixTime, but glide only occurs when playing legato.

Hold

When HOLD is on, any note (or notes in paraphonic mode) played will continue to play until HOLD is turned off.

When used in conjunction with the arpeggiator's Arp Auto Latch function, arpeggiated notes are latched on and replaced by any new note(s) struck. If HOLD is on and the Arp Auto Latch function is off, any new notes struck are added to the arpeggio.



Glide



Hold

Pitch and Modulation Wheels

The Pro 2 has a spring loaded pitch wheel and a modulation wheel. You can use these controls to enhance live performance by bending notes and adding modulation in real time as you play. The pitch wheel range can be set separately for bending up and down using the RANGE UP and RANGE DOWN parameters.

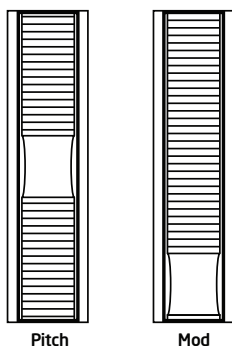

Range Up	Range Down		
2 semitones	2 semitones		
RANGE UP	RANGE DOWN		
Key Modes	Pitch Wheel		

To set the pitch bend range:

1. Press MISC PARAMS button.
2. Press the soft key 2 to select the PITCH WHEEL tab.
3. Use soft knob 1 (RANGE UP) to set the pitch bend up range.
4. Use soft knob 2 (RANGE DOWN) to set the pitch bend down range.

Assigning the Mod Wheel

The mod wheel is a modulation source and can be assigned to a modulation destination just like any other mod source. The difference is that you can perform the modulation in real time by moving the mod wheel. This is a great way to add expressiveness to a program.

Many programs use the mod wheel to add vibrato to a sound. In fact the Basic Program is set up this way. In this case, the mod wheel is routed to LFO 1 amount, which is in turn routed to the OSC ALL FREQ parameter (controlling the frequency of all oscillators). This has the end result of adding vibrato when you push the mod wheel up.

Using the mod matrix it's possible to assign multiple modulation destinations to the mod wheel. You could, for example control filter cutoff, sub oscillator level, distortion amount, and more, all from the mod wheel.



To display the modulation matrix, press the ASSIGN SOURCE or ASSIGN DEST buttons in the Modulation section. Modulations slots and routings appear in the OLED display.

Edit Mod 1	Source	Amount	Destination
Mod 1	Slider 1 Position	▶ 60 ▶	F1 Cutoff
Mod 2	Slider 2 Position	▶ 35 ▶	F1 Resonance
Mod 3	Aftertouch	▶ 25 ▶	Drive
Mod 4	Mod Wheel	▶ 80 ▶	Sub Osc Level
Slot Sort	Sort Source	Sort Dest	

To assign the mod wheel to a mod destination:

1. On the front panel MOD section, press and hold the ASSIGN SOURCE button.
2. Turn the mod wheel. The mod matrix appears in the display and the mod wheel is assigned to the first available modulation slot.
3. Turn soft knob 4 (DESTINATION) to choose a modulation destination.
4. Turn soft knob 3 (AMOUNT) to choose the maximum amount of modulation applied when the mod wheel is turned all the way up.
5. To route the mod wheel to more destinations, turn soft knob 1 (EDIT MOD #) to find an open modulation slot and choose MOD WHEEL.
6. Repeat steps 3-4.

Touch Sliders

The Pro 2 has two position- and pressure-sensitive touch sliders. Like the pitch and mod wheels, you can use these sliders to enhance live performance by adding modulation in real time as you play.

Each slider serves as two modulation sources, the values of which are determined by finger position and finger pressure. Those sources appear in the modulation matrix as Slider 1 Position, Slider 2 position, Slider 1 Pressure, and Slider 2 Pressure. (See *Modulation* on page 44.)

Normally, the sliders affect the assigned modulation destinations only while they're being touched. But when LATCH is on, the slider holds the value from the position at which it was touched last.



Press and hold ASSIGN MOD SOURCE and touch either of the sliders to assign Slider 1 Position or Slider 2 Position as a source in the modulation matrix.

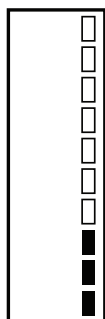

Slider 1

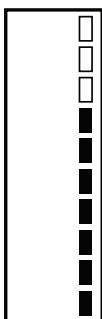

Slider 2

Use the mod matrix to assign modulation destinations to the sliders. You can route multiple modulation destinations to a slider. To display the modulation matrix, press the **ASSIGN SOURCE** or **ASSIGN DEST** buttons in the Modulation section. Modulations slots and routings appear in the OLED display.

Edit Mod 1	Source	Amount	Destination
Mod 1	Slider 1 Position	▶ 60 ▶	F1 Cutoff
Mod 2	Slider 2 Postion	▶ 35 ▶	F1 Resonance
Mod 3	Aftertouch	▶ 25 ▶	Drive
Mod4	Mod Wheel	▶ 80 ▶	Sub Osc Level
Slot Sort	Sort Source	Sort Dest	

To assign a slider to a mod destination:

1. On the front panel MOD section, press and hold the **ASSIGN SOURCE** button.
2. Touch slider 1. The mod matrix appears in the display and **SLIDER 1 POSITION** is assigned to an available modulation slot.



To assign slider pressure instead of position, tap the slider a second time.

3. Turn soft knob 4 (**DESTINATION**) to choose a modulation destination.
4. Turn soft knob 3 (**AMOUNT**) to choose the maximum amount of modulation applied when the mod wheel is turned all the way up.
5. To route the slider to more destinations, turn soft knob 1 (**EDIT MOD #**) to find an open modulation slot and choose **SLIDER 1 POSITION** (or pressure).
6. Repeat steps 3-4.

Play List

Play List enables programs to be organized into lists for quick and easy recall. This feature is particularly useful for live performance where it's nice to have specific groups of programs at your fingertips.

There are four play lists: Set 1, Set 2, Set 3, and Set 4. Each can hold and recall up to 16 programs using the 16 sequencer step buttons.



Play lists simply point to stored Factory or User programs. Editing and saving a program changes that program in memory and, as a result, in any play lists in which it appears. If you need a program to behave differently in different situations, save multiple copies of the program edited and named appropriately for each situation.

To create a play list:

1. Press the CUE/PLAY LIST button.
2. Press soft key 1 to select SET 1.
3. Press sequencer step button 1.
4. Use soft knob 1 (PROGRAM SELECT) and soft knob 2 (BANK SELECT) TO choose the desired program in the desired bank.
5. Next, press sequencer step button 2.
6. Use soft knob 1 (PROGRAM SELECT) and soft knob 2 (BANK SELECT) to choose the desired program to link to sequencer step button 2.
7. Repeat as desired to choose programs for sequencer step buttons 3-16.
8. Repeat with sets 2-4 as desired.



To export play lists as MIDI SysEx data, use DUMP ALL BANKS in the Global menu. All the play list data will be exported along with the bank data.

To recall programs from a play list:

1. Press the CUE/PLAY LIST button.
2. Press soft key 1, 2, 3, or 4 to select the desired Set (1-4).
3. Press a sequencer step button (1-16) to choose the program associated with that step button.

Cue

Cue lets you continuously run the sequencer while you switch from program to program. The sequence and sound associated with each program will play until it reaches its end, then change to the next program (and the sequence associated with it). If you save multiple versions of the same program, each with a different sequence, you can use Cue to switch through them in real time, effectively stringing multiple sequences together to create a “song” in real time.

To use Cue:

1. Press the SEQUENCER button to turn on the sequencer.
2. Press PLAY/STOP to start the sequencer.
3. Press and hold the CUE/PLAY LIST button.
4. Use soft knob 1 (PROGRAM SELECT) and soft knob 2 (BANK SELECT) to choose the desired program. Programs can also be selected from play list sets 1-4, using soft keys 1-4 and the numbered sequencer step buttons as described previously in the *Play List* section.
5. Release the CUE/PLAY LIST button. When the currently playing sequence reaches its end (its reset point) the Pro 2 switches to the newly chosen program and sequence.
6. Repeat steps 3- 5 as desired.



Pressing the RESET button while a sequence plays is a convenient way to add variation to a sequence by changing its length in real time. Each time you press RESET, the sequence immediately goes back to step 1.

Misc Parameters

The MISC PARAMETERS button allows you to access controls for a number of essential functions. These include glide mode, retrigger on/off, gate source, key assignment, and pitch wheel bend range.

Glide Mode	Retrigger	Gate Source	Key Assign
FixTimeA	On	Keyboard	Low Note
GLIDE MODE	RETRIGGER	GATE SOURCE	KEY ASSIGN
Key Modes	Pitch Wheel		

Range Up	Range Down		
2 semitones	2 semitones		
RANGE UP	RANGE DOWN		
Key Modes	Pitch Wheel		

To access Misc Parameters:

- Press the MISC PARAMS button on the front panel of the Pro 2.

Glide Mode: FixRate, FixRate A, FixTime, FixTime A—(In the KEY MODES tab) These modes determine how GLIDE behaves:

FixRate: The time to transition between notes varies with the interval between the notes; the greater the interval, the longer the transition time. The glide rate is fixed.

FixRate A: The same as FixRate, but glide is only applied when playing legato. That is, glide only occurs when a note is held until the next note is played. This effectively allows glide to be turned on and off from the keyboard.

FixTime: Glide is set to a fixed time, regardless of the interval between notes.

FixTime A: The same as FixTime, but glide only occurs when playing legato.

Retrigger: On, Off—*(In the KEY MODES tab)* Determines whether or not the envelopes are retriggered if a note is held while additional notes are played.

Gate Source: Keyboard, Ext Audio, CV 1, CV 2, CV 3, CV 4—*(In the KEY MODES tab)* Selects the source that triggers the Pro 2's envelopes.

Key Assign: Low Note, High Note, Last Note, Paraphonic—*(In the KEY MODES tab)* Selects the key priority when more than one key is played simultaneously. Choosing PARAPHONIC allows you to play chords of up to 4 notes at a time. LOW NOTE, HIGH NOTE and LAST NOTE are monophonic playback modes that give priority to the lowest, highest, or last note played, as their names imply.

Range Up: Off, 1...12 Semitones—*(In the PITCH WHEEL tab)* Selects the range in semitones when bending the Pitch Wheel upward. Twelve semitones equals 1 octave.

Range Down: Off, 1...24 Semitones—*(In the PITCH WHEEL tab)* Selects the range in semitones when bending the Pitch Wheel downward. Twenty-four semitones equals 2 octaves.

Using USB

The Pro 2's USB 2.0 port enables bidirectional MIDI communication with a computer. A MIDI interface and MIDI cables are not necessary, just a USB cable. The Pro 2 is a Class Compliant USB device. That means it does not require any additional drivers to be installed to communicate with a Mac or Windows computer. The Pro 2 transmits and receives MIDI data via USB, but does not transmit audio.



MIDI In and USB should not be used at the same time, as overlapping messages from different sources may cause the Pro 2 to respond unpredictably. MIDI Out and USB can be used at the same time and transmit the same data.

USB Notes

Under Mac OS X, “Pro 2 Keyboard” will appear as a MIDI port when connected via USB and can be configured using the Mac’s Audio MIDI Setup utility (typically found in Applications/Utilities).

Under Windows, the first time the Pro 2 is connected via USB, the “Found new hardware” alert appears and it is automatically installed as “Pro 2 Keyboard.”

In Windows, if you unplug the USB cable and plug it back in while a program has the Pro 2 port open, you may have to resync. That usually means going to the Pro 2 Keyboard Properties—in the Windows Device Manager under “Sound, video, and game controllers”—and clicking OK. If *Pro 2 Keyboard* is no longer listed in the Device Manager, power the Pro 2 down and back up again while it is connected via USB. It should be detected on power up.

A Few Tutorials

The Pro 2 is a very deep instrument with virtually endless sonic possibilities. Though step-by-step tutorials for all of its capabilities are outside the scope of this manual, this chapter provides a few short tutorials to help you explore some key features.

Processing External Audio

The Pro 2 makes a great effects processor. The example below shows you how connect external audio to the Pro 2 and process it in real time by tweaking knobs and controls.



To hear an external audio signal, you need to gate the VCA and filter open. When you do this, you will also hear the Pro 2's oscillators droning since they are continuously producing sound. To avoid continuous oscillator drone, set the **OUTPUT LEVEL** of all oscillators to zero. Alternatively, set the waveshapes of each oscillator to **OSC OFF**.

To process external audio:

1. Connect an instrument or audio signal to the **AUDIO IN** jack on the rear of the Pro 2 and turn up the instrument to a suitable level.
2. Adjust the **EXT. INPUT LEVEL** knob in the oscillator section of the Pro 2. (If you need to further boost the signal, adjust **EXT. IN GAIN** (soft knob 2 in the display).
3. Press the **HOLD** button then play a key on the keyboard. This holds the VCA open.
4. Turn the **SUSTAIN** knob on the amplifier envelope to 127.
5. Turn the **SUSTAIN** knob on the filter envelope to 127.
6. Play the external audio source.
7. Tweak parameters such as filter cutoff, distortion, drive, hack, feedback, delay (particularly the **TIME** parameter of delay 4!), and so on to process the sound.



Connect an expression pedal to the Pro 2 and route it to a parameter such as filter cutoff in the mod matrix for more real-time processing control over the audio input.

Filtering External Audio Using the Envelope Follower

The Pro 2's envelope follower makes it easy to process external audio with an “auto-wah” type effect. Add a little distortion and delay and this is a very expressive effect.

The Envelope Follower has controls for **ATTACK** and **RELEASE** in the **SUB OSC** tab. Access these parameters by turning the **OSC 1 SUB OCTAVE** knob on the front panel.

Sub Osc	Quad Level	Attack	Release
ENVELOPE FOLLOWER			
80 SUB OSC	99 QUAD LEVEL	25 ATTACK	40 RELEASE
Sub Osc	Ext Input	Air/Girth	Char FX



To avoid continuous oscillator drone, set the **OUTPUT LEVEL** of all Pro 2 oscillators to zero. Alternatively, set the waveshapes of each oscillator to **OSC OFF**.

To filter external audio with the envelope follower:

1. Connect an instrument or audio signal to the **AUDIO IN** jack on the rear of the Pro 2 and turn up the instrument to a suitable level.
2. In the Pro 2's **MOD** section, press the **ASSIGN SOURCE** button and choose **ENVELOPE FOLLOWER**.
3. With soft knob 4 (**DESTINATION**) choose **VCA** as the destination.
4. With soft knob 1 (**EDIT MOD**) choose a second available mod slot.
5. With soft knob 2 (**SOURCE**) choose **ENVELOPE FOLLOWER** as the source.
6. With soft knob 4 (**DESTINATION**) choose **F1 CUTOFF** (OR **F2 CUTOFF** if you're using Filter 2) as the destination.
7. Adjust the modulation **AMOUNT** for both modulation routings.
8. Adjust the **EXT. INPUT LEVEL** knob in the oscillator section of the Pro 2. (If you need to further boost the signal, adjust **EXT. IN GAIN** (soft knob 2 in the display.)
9. Play the external audio source.

10. Adjust **THRESHOLD** until the audio begins to trigger the envelopes.
11. Adjust the envelope follower's **ATTACK** and **RELEASE** if desired. (Access these parameters in the display by turning the **OSC 1 SUB OCTAVE** knob on the front panel.)
12. Adjust the front panel filter **CUTOFF** and **RESONANCE** parameters as desired.
13. Adjust any other parameters such as distortion and delay to tailor the sound.



Connect an expression pedal to the Pro 2 and route it to filter cutoff in the mode matrix for more real-time control over the wah effect.

Syncing the Sequencer with an External MIDI Device

It's possible to sync the Pro 2's sequencer with an external MIDI device such as a *Tempest* drum machine or digital audio workstation using MIDI clock.

To sync a sequence to an external MIDI clock:

1. Connect the external MIDI device's MIDI Out to the MIDI In of the Pro 2.
2. Set the external MIDI device to MIDI Clock Master.
3. On the Pro 2, press the **GLOBAL** button and select **MIDI CLOCK MODE** (menu item 4). Then set **MIDI CLOCK MODE** to **SLAVE**.
4. Also in the **GLOBAL** menu, set **MIDI CLOCK CABLE** to **MIDI PORT**.
5. Press the **SEQUENCER** button to turn on the sequencer.
6. Set **PLAY SOURCE** to **SEQUENCER**.
7. Set **PLAY MODE** to **NORMAL**.
8. Start MIDI playback on the external device. The Pro 2 sequencer will start and stop playback in response to MIDI Start/Stop/Continue messages.



If you have a sequencer track assigned to a MIDI channel output and it is only sending MIDI note-off messages, check the value of the Velocity parameter for each step. A velocity greater than zero must be set for a MIDI note-on message to be sent. If the velocity for a given step is set to zero, only a MIDI note-off message will be sent for that step.

Using Pro 2's CV Outs to Control a Modular Synth

The Pro 2 can easily interface with modular synths through its four control voltage inputs and outputs. This makes it possible to use the Pro 2 as the central hub of a modular system.

For example, you could play the modular synth's oscillators from the Pro 2 keyboard. You could also use the Pro 2's sequencer to modulate the external synth's filters. You could even use the Pro 2's position- and pressure-sensitive sliders to perform real-time modulation of the modular synth. The possibilities are extensive.

In the example below, the Pro 2 keyboard is used to play an oscillator on a modular synth.

To use the Pro 2's CV Outs to control the oscillator of a modular synth:

1. Using a 1/8 inch patch cable, connect the Pro 2's CV Out 1 to the appropriate CV In on the modular synth's oscillator module. (The input should support a 1-volt-per-octave signal.)
2. On the Pro 2, press the ASSIGN SOURCE button in the Mod section.
3. Using soft knob 1, choose an available mod slot.
4. Using soft knob 2, select NOTE NUMBER number as the mod source.
5. Using soft knob 4, select EXT CV OUT 1 the mod destination.
6. Using soft knob 3, set the mod AMOUNT to 127. (Anything less than this will affect pitch scaling.)
7. Play the Pro 2 keyboard. The modular synth's oscillator should respond to the notes. (You may need to tune the modular synth's oscillators to match the Pro 2's oscillators.)



Use the same basic procedure to route modulation sources such as sequencer tracks, the touch sliders, the mod wheel, and so on, to the modular synth. In this way you can use the Pro 2 as the central controller for a larger modular system.

If pitch tracking between the Pro 2's keyboard and the external oscillator module isn't perfect, you may need to scale the Pro 2's CV output.

To scale the Pro 2's CV Out:

1. Play the note A = 440 on the Pro 2 keyboard.
2. Tune the external modular oscillator to the same pitch.
3. Play different octaves to check for pitch consistency across the key range.
4. If the pitch scaling isn't perfect, press the GLOBAL button and in the display, select CV OUT SCALE for the CV output that you're using (in the previous example, CV OUT 1).
5. Use soft knob 3 to tweak the scaling while you play different octaves across the keyboard. Keep adjusting until scaling across the entire key range is correct.

More About Pro 2's CV Outputs

The Pro 2 is extremely flexible when it comes to Control Voltages, and it can be configured to accurately interact with virtually all Eurorack modules. The Pro 2's CV outputs have a range of 0 to 10v. Since the range is 0-10v, Middle C is sent from the CV output at 5v. This allows the CV out to track over a 10 octave range, from 0 to 10v.

There is no standard input voltage range for Eurorack modules. Some modules and external synthesizers have a 10v input range, while others have a 5v input range. Using the DC OFFSET parameter in the Modulation Matrix, you can configure the Pro 2 as necessary to work correctly with your specific module.

You can also assign the keyboard and sequencer of the Pro 2 to transmit CV data at 1v/octave by assigning NOTE NUMBER to modulate CV OUT (1-4)" with an AMOUNT of "127" in the Mod Matrix.

For example, if the Pro 2 sends CV at 1v/octave to an oscillator that has a maximum input range of 5v, sending Middle C from the Pro 2 will result in the oscillator playing at its highest frequency.

There are a couple ways to correct for this offset:

- Use an external attenuator.
- Alternatively, apply a negative DC OFFSET to the CV output via the Modulation Matrix. This will allow Pro 2 to compensate for the voltage difference internally.

To configure the Pro 2 to control an external oscillator which has a 5v input range from the Mod Matrix:

1. In Mod Slot 1, choose NOTE NUMBER as the source; choose EXT CV OUT 1 as the destination; and set the modulation AMOUNT to 127. This will set the CV output to scale at 1v/octave when a note is played.
2. In Mod Slot 2, choose DC as the source; choose EXT CV OUT 1 as the destination; and set the modulation amount to -64. The DC offset of -64 will apply a -5v offset to the CV.
3. An external oscillator with a 5v range will now track at the same octave as the Pro 2's internal oscillators. You can adjust the DC offset for other maximum voltages as well.

General guidelines:

- DC OFFSET value of -16 would equal a -1.25v offset to the CV output.
- DC OFFSET value of -32 would equal a -2.5v offset to the CV output.
- DC OFFSET value of -48 would equal a -3.75v offset to the CV output.

And so on.

You can also make incremental adjustments to the DC offset to fit your specific application.

Look for More Tutorials Online

More tutorials for the Pro 2 are available on the DSI website. We recommend that you check the Pro 2 Product Page regularly for not only tutorials, but new sound banks, operating system updates, manual updates, and more. Visit: www.davesmithinstruments.com.

Appendix A: Modulation Sources

Off
Osc 1
Osc 2
Osc 3
Osc 4
LFO 1
LFO 2
LFO 3
LFO 4
F1 Env
F2 Env
VCA Env
Env 4
Env 5
Pitchbend
Mod Wheel
Slider 1 Position
Slider 2 Position
Slider 1 Pressure
Slider 2 Pressure
Aftertouch
CC#2: Breath
CC#4: Foot Pedal
CC#11: Expression
Velocity
Note Number
Random
DC
Audio Out *
Ext Audio In

Envelope Follower
Peak Hold
CV Input 1
CV Input 2
CV Input 3
CV Input 4
Seq Track 1
Seq Track 2
Seq Track 3
Seq Track 4
Seq Track 5
Seq Track 6
Seq Track 7
Seq Track 8
Seq Track 9
Seq Track 10
Seq Track 11
Seq Track 12
Seq Track 13
Seq Track 14
Seq Track 15
Seq Track 16

* Audio Out is the digitized audio signal after the Amplifier VCA.

Appendix B: Modulation Destinations

Off
Osc 1 Freq
Osc 2 Freq
Osc 3 Freq
Osc 4 Freq
Osc All Freq
Osc 1 Level
Osc 2 Level
Osc 3 Level
Osc 4 Level
Osc 1 Shape Mod
Osc 2 Shape Mod
Osc 3 Shape Mod
Osc 4 Shape Mod
Sub Osc Level
Osc 1 FM
Osc 2 FM
Osc 3 FM
Osc 4 FM
Osc All FM
Osc 1 AM
Osc 2 AM
Osc 3 AM
Osc 4 AM
Osc All AM
Osc All Slop
Air
Girth
Hack
Decimate

Drive
F1 Cutoff
F1 Resonance
F2 Cutoff
F2 Resonance
F2 LP-Notch-HP
F2 Normal-BP
Filter Out Mix
Serial-Parallel
VCA
Pan
Distortion
Feedback Amount
Feedback Tuning
Delay 1 Amount
Delay 2 Amount
Delay 3 Amount
Delay 4 Amount
Delay 1 Time
Delay 2 Time
Delay 3 Time
Delay 4 Time
Delay 1 Feedback
Delay 2 Feedback
Delay 3 Feedback
Delay 4 Feedback
Delay 1 Pan
Delay 2 Pan
Delay 3 Pan
Delay 4 Pan

LFO 1 Freq
LFO 2 Freq
LFO 3 Freq
LFO 4 Freq
LFO 1 Amount
LFO 2 Amount
LFO 3 Amount
LFO 4 Amount
F1 Env Amount
F2 Env Amount
Amp Env Amount
Env 4 Amount
Env 5 Amount
F1 Env Attack
F2 Env Attack
Amp Env Attack
Env 4 Attack
Env 5 Attack
All Env Attack
F1 Env Decay
F2 Env Decay
Amp Env Decay
Env 4 Decay
Env 5 Decay
All Env Decay
F1 Env Release
F2 Env Release
Amp Env Release
Env 4 Release
Env 5 Release
All Env Release
Mod 1 Amount
Mod 2 Amount
Mod 3 Amount

Mod 4 Amount
Mod 5 Amount
Mod 6 Amount
Mod 7 Amount
Mod 8 Amount
Mod 9 Amount
Mod 10 Amount
Mod 11 Amount
Mod 12 Amount
Mod 13 Amount
Mod 14 Amount
Mod 15 Amount
Mod 16 Amount
Ext CV Out 1
Ext CV Out 2
Ext CV Out 3
Ext CV Out 4
Seq Out 1 Ch 1
Seq Out 1 Ch 2
Seq Out 1 Ch 3
Seq Out 1 Ch 4
Seq Out 1 Ch 5
Seq Out 1 Ch 6
Seq Out 1 Ch 7
Seq Out 1 Ch 8
Seq Out 1 Ch 9
Seq Out 1 Ch 10
Seq Out 1 Ch 11
Seq Out 1 Ch 12
Seq Out 1 Ch 13
Seq Out 1 Ch 14
Seq Out 1 Ch 15
Seq Out 1 Ch 16
Seq Out 2 Ch 1

Seq Out 2 Ch 2
Seq Out 2 Ch 3
Seq Out 2 Ch 4
Seq Out 2 Ch 5
Seq Out 2 Ch 6
Seq Out 2 Ch 7
Seq Out 2 Ch 8
Seq Out 2 Ch 9
Seq Out 2 Ch 10
Seq Out 2 Ch 11
Seq Out 2 Ch 12
Seq Out 2 Ch 13
Seq Out 2 Ch 14
Seq Out 2 Ch 15
Seq Out 2 Ch 16

Appendix C: Delay Times (Delays 1-3)

Value	Time (msec)
0+	0.9556
1	1.0124
2	1.0726
3	1.1364
4	1.2039
5	1.2755
6	1.3514
7	1.4317
8	1.5169
9	1.6071
10	1.7026
11	1.8039
12	1.9111
13	2.0248
14	2.1452
15	2.2727
16	2.4079
17	2.5511
18	2.7027
19	2.8635
20	3.0337
21	3.2141
22	3.4052
23	3.6077
24	3.8223
25	4.0495
26	4.2903
27	4.5455
28	4.8157

Value	Time (msec)
29	5.1021
30	5.4055
31	5.7269
32	6.0675
33	6.4282
34	6.8105
35	7.2155
36	7.6445
37	8.0991
38	8.5807
39	9.0909
40	9.6315
41	10.2042
42	10.8110
43	11.4538
44	12.1349
45	12.8565
46	13.6210
47	14.4309
48	15.2890
49	16.1982
50	17.1614
51	18.1818
52	19.2630
53	20.4084
54	21.6219
55	22.9077
56	24.2698
57	25.7130

Value	Time (msec)
58	27.2419
59	28.8618
60	30.5781
61	32.3963
62	34.3227
63	36.3636
64	38.5259
65	40.8168
66	43.2439
67	45.8153
68	48.5396
69	51.4259
70	54.4839
71	57.7237
72	61.1561
73	64.7926
74	68.6454
75	72.7273
76	77.0519
77	81.6336
78	86.4878
79	91.6306
80	97.0793
81	102.8519
82	108.9678
83	115.4474
84	122.3122
85	124.7166
86	129.8653

Value	Time (msec)
87	135.0140
88	140.1627
89	145.3115
90	150.4602
91	155.6089
92	160.7576
93	165.9064
94	171.0551
95	176.2038
96	181.3525
97	186.5013
98	191.6500
99	196.7987
100	201.9474
101	207.0962
102	212.2449
103	217.3936
104	222.5424
105	227.6911
106	232.8398
107	237.9885
108	243.1373
109	248.2860
110	253.4347
111	258.5834
112	263.7322
113	268.8809
114	274.0296
115	279.1783
116	284.3271
117	289.4758
118	294.6245

Value	Time (msec)
119	299.7732
120	304.9220
121	310.0707
122	315.2194
123	320.3681
124	325.5169
125	330.6656
126	335.8143
127	340.9631
128	346.1118
129	351.2605
130	356.4092
131	361.5580
132	366.7067
133	371.8554
134	377.0041
135	382.1529
136	387.3016
137	392.4503
138	397.5990
139	402.7478
140	407.8965
141	413.0452
142	418.1939
143	423.3427
144	428.4914
145	433.6401
146	438.7888
147	443.9376
148	449.0863
149	454.2350
150	459.3838

Value	Time (msec)
151	464.5325
152	469.6812
153	474.8299
154	479.9787
155	485.1274
156	490.2761
157	495.4248
158	500.5736
159	505.7223
160	510.8710
161	516.0197
162	521.1685
163	526.3172
164	531.4659
165	536.6146
166	541.7634
167	546.9121
168	552.0608
169	557.2096
170	562.3583
171	567.5070
172	572.6557
173	577.8045
174	582.9532
175	588.1019
176	593.2506
177	598.3994
178	603.5481
179	608.6968
180	613.8455
181	618.9943
182	624.1430

Value	Time (msec)
183	629.2917
184	634.4404
185	639.5892
186	644.7379
187	649.8866
188	655.0353
189	660.1841
190	665.3328
191	670.4815
192	675.6303
193	680.7790
194	685.9277
195	691.0764
196	696.2252
197	701.3739
198	706.5226
199	711.6713
200	716.8201
201	721.9688
202	727.1175
203	732.2662
204	737.4150
205	742.5637
206	747.7124
207	752.8611
208	758.0099
209	763.1586
210	768.3073
211	773.4560
212	778.6048
213	783.7535
214	788.9022

Value	Time (msec)
215	794.0510
216	799.1997
217	804.3484
218	809.4971
219	814.6459
220	819.7946
221	824.9433
222	830.0920
223	835.2408
224	840.3895
225	845.5382
226	850.6869
227	855.8357
228	860.9844
229	866.1331
230	871.2818
231	876.4306
232	881.5793
233	886.7280
234	891.8768
235	897.0255
236	902.1742
237	907.3229
238	912.4717
239	917.6204
240	922.7691
241	927.9178
242	933.0666
243	938.2153
244	943.3640
245	948.5127
246	953.6615

Value	Time (msec)
247	958.8102
248	963.9589
249	969.1076
250	974.2564
251	979.4051
252	984.5538
253	989.7025
254	994.8513
255	1000.0000

Appendix D:

MIDI Implementation

Pro 2 receives MIDI data according to the mode controls under GLOBAL. In addition, there is interaction between some of the Program parameters that determine the overall response of Pro 2 to MIDI data. Following are the Global parameters that affect response to MIDI:

MIDI Channel: ALL, 1...16 — Selects the MIDI channel to send and receive data, 1 to 16. All receives on any channel.

MIDI Clock Mode: See table — Selects the MIDI clock status:

Display	MIDI Clock Setting
Off	MIDI clock is neither sent nor received
Master	MIDI clock is sent, but not received
Slave	MIDI clock is received, but not sent
Slave Thru	MIDI clock is received and passed to MIDI Out

MIDI Clock Cable: MIDI Port, USB—Selects the MIDI port by which MIDI clock data is transmitted and received.

MIDI Parameter Send: NRPN, CC, Off—Changes to the values of Pro 2's front panel controls are transmitted via MIDI as Non-registered Parameter Number (NRPN) controllers or as Continuous Controllers (CC). Transmission of parameters can also be turned off.

MIDI Parameter Receive: All, NRPN, CC, Off—Sets the method by which Pro 2 receives parameter changes via MIDI. As with transmission, NRPNs are the preferred method, though some controllers may only be able to send CCs.

MIDI Control Enable: Off, On—When On, the synth will respond to MIDI control messages, including Pitch Wheel, Mod Wheel, Pedal, Breath, Volume, and Expression.

MIDI SysEx Enable: Off, On—When On, the synth will respond to received MIDI SysEx messages, and will transmit them, when prompted, to the MIDI Out.

MIDI Out Select: Off, MIDI, USB, MIDI+USB—Selects the output to use for MIDI transmissions.

MIDI Messages

System Real-Time Messages

Status	Description
1111 1000	MIDI Timing Clock

Received Channel Messages

Status	Second	Third	Description
1000 nnnn	0kkkkkkk	0vvvvvvv	Note Off. Velocity is ignored
1001 nnnn	0kkkkkkk	0vvvvvvv	Note On. Note off if vvvvvvv = 0
1010 nnnn	0kkkkkkk	0vvvvvvv	Polyphonic Key Pressure
1011 nnnn	0vvvvvvv	0vvvvvvv	Control Change; see "Received Controller Messages"
1100 nnnn	0ppppppp		Program change, 0-127 for Programs 1-128 within current Bank
1101 nnnn	0vvvvvvv		Channel Pressure
1110 nnnn	0vvvvvvv	0vvvvvvv	Pitch Bend LS Byte then MS Byte

Notes: 0kkkkkkk Note number 0 — 127
 nnnn Channel number 0 to 15 (MIDI channel 1-16).
 Ignored if MIDI channel set to ALL
 Value

Received Controller Messages

Status	Second	Third	Description
1011 nnnn	1	0vvvvvvv	Mod Wheel: directly assignable controller
1011 nnnn	2	0vvvvvvv	Breath Controller: directly assignable controller
1011 nnnn	4	0vvvvvvv	Foot Controller: directly assignable controller
1011 nnnn	7	0vvvvvvv	Volume: Combined with Master Volume and Voice Volume
1011 nnnn	74	0vvvvvvv	Brightness: Added to low-pass filter cutoff frequency
1011 nnnn	11	0vvvvvvv	Expression Controller: directly assignable controller

Status	Second	Third	Description
1011 nnnn	32	0vvvvvvv	Bank Select: 0 - 3 select user banks 1 - 4; 4 - 7 select factory banks 1 - 4; others ignored
1011 nnnn	64	0vvvvvvv	Damper pedal: Holds envelopes in Sustain if 0100 0000 or higher
1011 nnnn	123	0vvvvvvv	All Notes Off: Clear all MIDI notes
1011 nnnn	121	0vvvvvvv	Reset All Controllers: Clears all MIDI controllers to 0, MIDI volume to maximum

See sections below for additional Continuous Controller (CC) and Non-registered Parameter Number (NRPN) messages received.

Transmitted Channel Messages

Status	Second	Third	Description
1000 nnnn	0kkkkkkk	0000000	Note Off.
1001 nnnn	0kkkkkkk	0vvvvvvv	Note On.
1011 nnnn	0vvvvvvv	0vvvvvvv	Control Change; see "Transmitted Controller Messages"
1100 nnnn	0ppppppp		Program change, 0-98 for Programs 1-99 within current Bank
1101 nnnn	0vvvvvvv		Channel Pressure
1110 nnnn	0vvvvvvv	0vvvvvvv	Pitch Bend LS Byte then MS Byte

Notes: 0kkkkkkk Note number 0 — 127
 nnnn Channel number 0 to 15 (MIDI channel 1-16).
 Ignored if MIDI channel set to ALL
 0vvvvvvv Value

Transmitted Controller Messages

Status	Second	Third	Description
1011 nnnn	0000 0001	0vvvvvvv	Mod Wheel
1011 nnnn	0000 0010	0vvvvvvv	Breath Controller: When assigned to Pedal 1 or Pedal 2
1011 nnnn	0000 0100	0vvvvvvv	Foot Controller: When assigned to Pedal 1 or Pedal 2
1011 nnnn	0000 0111	0vvvvvvv	Volume: When assigned to Pedal 1 or Pedal 2

1011 nnnn	0100 1010	0vvvvvvv	Brightness: When assigned to Pedal 1 or Pedal 2
1011 nnnn	0000 1101	0vvvvvvv	Expression: When assigned to Pedal 1 or Pedal 2
1011 nnnn	0010 0000	0vvvvvvv	Bank Select: 0 - 7
1011 nnnn	0100 0000	0vvvvvvv	Damper pedal: Sends 0 if off, 0111 1111 when on
1011 nnnn	0000 0111	0vvvvvvv	Volume knob

See sections below for additional Continuous Controller (CC) and Non-registered Parameter Number (NRPN) messages transmitted.

Additional Continuous Controllers Transmitted/Received

The following table details how MIDI Continuous Controllers (CCs) are mapped onto Pro 2's controls. They are transmitted when MIDI Param Send is set to CC in Global, and recognized when received when MIDI Param Receive is set to CC in the Global menu.

CC#	Param
1	Mod Wheel
2	Breath
3	BPM
4	Foot Controller
5	Glide Mode
6	Data Entry MSB
7	Volume
8	Osc 1 Sub Octave
9	Distortion Amount
10	Expression
14	Slider 1 Position
15	Slider 2 Position
16	Slider 1 Pressure
17	Slider 2 Pressure

CC#	Param
18	Delay 1 Time
19	Delay 1 Sync
20	Delay 1 Amount
21	Delay 1 Feedback
23	Delay 2 Time
24	Delay 2 Sync
25	Delay 2 Amount
26	Delay 2 Feedback
28	Delay 3 Time
29	Delay 3 Sync
30	Delay 3 Amount
31	Delay 3 Feedback
32	Bank Select
33	Delay 4 Time

CC#	Param
34	Delay 4 Sync
35	Delay 4 Amount
36	Delay 4 Feedback
38	Data Entry LSB
39	Program Volume
40	VCA Envelope Amt
41	Velocity to VCA Env Amt
42	VCA Env Delay
43	VCA Env Attack
44	VCA Env Decay
45	VCA Env Sustain
46	VCA Env Release
47	F1 Envelope Amt
48	Velocity to F1 Env Amt
49	F1 Env Delay
50	F1 Env Attack
51	F1 Env Decay
52	F1 Env Sustain
53	F1 Env Release
54	Osc 1 Glide Amt
55	Osc 2 Glide Amt
56	Osc 3 Glide Amt
57	Osc 4 Glide Amt
58	Arpeggiator On/Off
59	Arpeggiator Mode
60	Arpeggiator Range
61	Arp Auto Latch On/Off
62	Seq/Arp Clock Divide
63	Arp Repeats
64	Pedal 2
65	Glide On/Off

CC#	Param
67	Osc 1 Pitch
68	Osc 1 Fine Tune
69	Osc 1 Level
70	Osc 1 Shape
71	Osc 1 Shape Mod
72	Osc 1 FM
73	Osc 1 AM
74	Brightness
75	Osc 2 Pitch
76	Osc 2 Fine Tune
77	Osc 2 Level
78	Osc 2 Shape
79	Osc 2 Shape Mod
80	Osc 2 FM
81	Osc 2 AM
82	Osc 3 Pitch
83	Osc 3 Fine Tune
84	Osc 3 Level
85	Osc 3 Shape
86	Osc 3 Shape Mod
87	Osc 3 FM
88	Osc 3 AM
89	Osc 4 Pitch
90	Osc 4 Fine Tune
91	Osc 4 Level
92	Osc 4 Shape
93	Osc 4 Shape Mod
94	Osc 4 FM
95	Osc 4 AM
96	Data Inc
97	Data Dec

CC#	Param
98	NRPN LSB
99	NRPN MSB
100	RPN LSB
101	RPN MSB
102	F1 Frequency
103	F1 Resonance
104	F1 Key Amount
106	F2 Frequency
107	F2 Resonance
108	F2 Key Amount
109	Girth
110	Air
111	Hack
112	Decimate
113	Drive
114	Feedback Amount
115	Feedback Tuning

NRPN Messages

The Non-Registered Parameter Number (NRPN) MIDI messages are used to transmit and receive both global and program parameters. They are transmitted when MIDI Parameter Send is set to NRPN in Global, and received when MIDI Parameter Receive is set to NRPN in Global.

The messages are handled in standard MIDI format using the NRPN CC commands in running status byte format. Below is the format used for transmitting a NRPN parameter.

Transmitted NRPN Messages

Status	Description
1011 nnnn	Control Change
0110 0011	NRPN parameter number MSB CC
0vvv vvvv	Parameter Number MSB
0110 0010	NRPN parameter number LSB CC
0vvv vvvv	Parameter Number LSB
0000 0110	NRPN parameter value MSB CC
0vvv vvvv	Parameter value MSB
0010 0110	NRPN parameter value LSB CC
0vvv vvvv	Parameter value LSB

The parameter number can be found in the two tables below, one for Global parameters, and the other for Program parameters. The parameter numbers and the parameter values are broken into two 7-bit bytes for MIDI transmission; the LSB has the seven least-significant bits, and the MSB has the seven most-significant bits, though in most cases the MSB will be zero or one, and never more than two.

When receiving an NRPN, all messages do not necessarily need to be transmitted, since the synth will track the most recent NRPN number, though it is usually good practice to send the entire message above.

Once an NRPN is selected, the synth will also respond to NRPN Data Increment and Decrement commands, which some controllers utilize. Finally, it responds to one RPN (Registered Parameter Number) command, the RPN/NRPN Reset command, which can be handy for resetting the currently selected parameter to a known state.

Received NRPN Messages

Status	Second	Third	Description
1011 nnnn	0110 0011	0vvvvvvv	NRPN parameter number MSB CC
1011 nnnn	0110 0010	0vvvvvvv	NRPN parameter number LSB CC
1011 nnnn	0000 0110	0vvvvvvv	NRPN parameter value MSB CC
1011 nnnn	0010 0110	0vvvvvvv	NRPN parameter value LSB CC
1011 nnnn	0110 0000	0xxxxxxx	NRPN parameter value Increment
1011 nnnn	0110 0001	0xxxxxxx	NRPN parameter value Decrement
1011 nnnn	0010 0101	01111111	RPN parameter number MSB CC - Reset NRPN parameter number (when both MSB and LSB received)
1011 nnnn	0010 0100	01111111	RPN parameter number LSB CC - Reset NRPN parameter number (when both MSB and LSB received)

Global Parameter Data

The following table shows the Global data that is sent and received on global parameter dumps, and the corresponding NRPN number when sent/received individually.

NRPN	Range	Description
1024	0-24	Master Coarse Tune
1025	0-100	Master Fine Tune
1026	0-16	MIDI Channel 0 = All
1027	0-3	MIDI Clock Mode 0 = Off 1 = Master 2 = Slave 3 = Slave Thru
1028	0-1	MIDI Clock Cable 0 = MIDI Port 1 = USB
1029	0-2	MIDI Param Send* 0 = NRPN 1 = CC 2 = Off

NRPN	Range	Description
1030	0-2	MIDI Param Receive† 0 = NRPN 1 = CC 2= Off
1031	0-1	MIDI Control Enable 0 = Off 1 = On
1032	0-1	MIDI SysEx Enable 0 = Off 1 = On
1033	0-2	MIDI SysEx Cable 0 = None 1= MIDI Port 2 = USB
1034	0-3	MIDI Out Select 0 = Off 1 = MIDI 2 = USB 3 = MIDI+USB
1035	0-1	Local Control* 0 = Off 1 = On
1036	0-1	Mono/Stereo 0 = Stereo 1 = Mono
1037	0-2	Pot Mode 0 = Relative 1= PassThru 2 = Jump
1038	0-1	Sustain Footswitch 0 = normally open 1= normally closed
1039	0-1	Sustain Pedal Function 0 = sustain 1 = arpeggiator on/off

NRPN	Range	Description
1040	0-5	Pedal 1 Function 0 = Breath Control 1 = Foot Controller 2 = Expression 3 = Master Volume 4 = Filter 1 & 2 Frequency, full range 5 = Filter 1 & 2 Frequency, half range
1041	0-1	Pedal Polarity 0 = Normal 1 = Reverse
1042	0-1	Aftertouch Enable 0 = Off 1 = On
1043	0-3	Aftertouch Curve
1044	0-3	Velocity Curve
1045	0-1	MIDI Thru/Out 2 0 = Thru 1 = Out 2

*Controller received, but not transmitted.

†Controller transmitted, but ignored when received.

Program Parameter Data

The following table lists Pro 2's program parameters.

NRPN	Value	Description
0	0-120	Osc 1 Pitch
1	0-100	Osc 1 Fine Tune
2	0-127	Osc 1 Level
3	0-32	Osc 1 Shape 0 = Off 1 = Sawtooth 2 = Super Saw 3 = Pulse 4 = Triangle 5 = Sine 6 = Tines 7 = Mellow 8 = Church 9 = Muted 10 = Nasal 11 = Boing 12 = Gothic 13 = Ahhh 14 = Shrii 15 = Ohhhh 16 = Buzzzz 17 = Meh 18 = Super Tines 19 = Super Mellow 20 = Super Church 21 = Super Muted 22 = Super Nasal 23 = Super Boing 24 = Super Gothic 25 = Super Ahhh 26 = Super Shrii 27 = Super Ohhhh 28 = Super Buzzzz 29 = Super Meh 30 = Red Noise 31 = White Noise 32 = Violet Noise
4	0-127	Osc 1 Shape Mod

NRPN	Value	Description
5	0-11	Osc 1 Wave Left 0 = Tines 1 = Mellow 2 = Church 3 = Muted 4 = Nasal 5 = Boing 6 = Gothic 7 = Ahhh 8 = ShriII 9 = Ohhhh 10= Buzzzz 11 = Meh
6	0-11	Osc 1 Wave Right (see Osc 1 Wave Left)
7	0-255	Osc 1 FM
8	0-255	Osc 1 AM
9	0-127	Osc 1 Slop
10	0-127	Osc 1 Glide Amount
11	0-1	Osc 1 Sync 0 = Off 1 = On
12	0-1	Osc 1 Key Follow 0 = Off 1 = On
13	0-1	Osc 1 Wave Reset 0 = Off 1 = On
18	0-120	Osc 2 Pitch
19	0-100	Osc 2 Fine Tune
20	0-127	Osc 2 Level
21	0-32	Osc 2 Shape (see Osc 1 Shape)
22	0-127	Osc 2 Shape Mod
23	0-11	Osc 2 Wave Left (see Osc 1 Wave Left)
24	0-11	Osc 2 Wave Right (see Osc 1 Wave Left)
25	0-255	Osc 2 FM
26	0-255	Osc 2 AM
27	0-127	Osc 2 Slop
28	0-127	Osc 2 Glide Amount

NRPN	Value	Description
29	0-1	Osc 2 Sync 0 = Off 1 = On
30	0-1	Osc 2 Key Follow 0 = Off 1 = On
31	0-1	Osc 2 Wave Reset 0 = Off 1 = On
36	0-120	Osc 3 Pitch
37	0-100	Osc 3 Fine Tune
38	0-127	Osc 3 Level
39	0-32	Osc 3 Shape (see Osc 1 Shape)
40	0-127	Osc 3 Shape Mod
41	0-11	Osc 3 Wave Left (see Osc 1 Wave Left)
42	0-11	Osc 3 Wave Right (see Osc 1 Wave Left)
43	0-255	Osc 3 FM
44	0-255	Osc 3 AM
45	0-127	Osc 3 Slop
46	0-127	Osc 3 Glide Amount
47	0-1	Osc 3 Sync 0 = Off 1 = On
48	0-1	Osc 3 Key Follow 0 = Off 1 = On
49	0-1	Osc 3 Wave Reset 0 = Off 1 = On
54	0-120	Osc 4 Pitch
55	0-100	Osc 4 Fine Tune
56	0-127	Osc 4 Level
57	0-19	Osc 4 Shape (see Osc 1 Shape)
58	0-127	Osc 4 Shape Mod
59	0-11	Osc 4 Wave Left (see Osc 1 Wave Left)
60	0-11	Osc 4 Wave Right (see Osc 1 Wave Left)

NRPN	Value	Description
61	0-255	Osc 4 FM
62	0-255	Osc 4 AM
63	0-127	Osc 4 Slop
64	0-127	Osc 4 Glide Amount
65	0-1	Osc 4 Sync 0 = Off 1 = On
66	0-1	Osc 4 Key Follow 0 = Off 1 = On
67	0-1	Osc 4 Wave Reset 0 = Off 1 = On
72	0-127	Osc 1 Sub Octave
73	0-3	Glide Mode 0 = FixRate 1 = FixRate A 2 = FixTime 3 = FixTime A
74	0-1	Glide 0 = Off 1 = On
75	0-12	Pitchbend Range Up
76	0-24	Pitchbend Range Down
80	0-127	Air
81	0-127	Girth
82	0-127	Hack
83	0-127	Decimate
84	0-127	Drive
90	0-164	Filter 1 Frequency
91	0-127	Filter 1 Resonance
92	0-127	Filter 1 Key Amount
93	0-127	Filter 1 Boost
94	0-127	Filter 2 Frequency
95	0-127	Filter 2 Resonance
96	0-127	Filter 2 Key Amount

NRPN	Value	Description
97	0-127	Filter 2 Mode 0 = Low-Pass 63 = Notch 127 = High-Pass
98	0-127	Normal to Band-Pass (continuously variable) 0 = Normal State-Variable (LP, N, HP) 127 = Band-Pass
99	0-3	Filter Selection 0 = Filter 1 enabled 1 = Filter 2 enabled 2 = Filter 1 & 2 enabled 3 = Split Oscillators on
100	0-127	Filter Routing, Serial to Parallel 0 = Fully Serial, F1 into F2 127 = Fully Parallel
105	0-254	Feedback Amount 0 to 126 = -127 to -1 127 = 0 128 to 254 = 1 to 127
106	0-48	Feedback Tuning
107	0-127	Voice Volume
109	0-127	Distortion Amount
111	0-127	VCA Envelope Amt
112	0-127	Velocity to VCA Env Amt
113	0-127	VCA Env Delay
114	0-127	VCA Env Attack
115	0-127	VCA Env Decay
116	0-127	VCA Env Sustain
117	0-127	VCA Env Release
118	0-1	VCA Env Repeat 0 = Off 1 = On
122	0-254	Filter 1 Envelope Amt 0 to 126 = -127 to -1 127 = 0 128 to 254 = 1 to 127
123	0-127	Velocity to Filter 1 Env Amt
124	0-127	Filter 1 Env Delay

NRPN	Value	Description
125	0-127	Filter 1 Env Attack
126	0-127	Filter 1 Env Decay
127	0-127	Filter 1 Env Sustain
128	0-127	Filter 1 Env Release
129	0-1	Filter 1 Env Repeat 0 = Off 1 = On
133	0-254	Filter 2 Envelope Amt 0 to 126 = -127 to -1 127 = 0 128 to 254 = 1 to 127
134	0-127	Velocity to Filter 2 Env Amt
135	0-127	Filter 2 Env Delay
136	0-127	Filter 2 Env Attack
137	0-127	Filter 2 Env Decay
138	0-127	Filter 2 Env Sustain
139	0-127	Filter 2 Env Release
140	0-1	Filter 2 Env Repeat 0 = Off 1 = On
144	0-254	Envelope 4 Amt
145	0-127	Velocity to Env 4 Amt 0 to 126 = -127 to -1 127 = 0 128 to 254 = 1 to 127
146	0-127	Envelope 4 Delay
147	0-127	Envelope 4 Attack
148	0-127	Envelope 4 Decay
149	0-127	Envelope 4 Sustain
150	0-127	Envelope 4 Release
151	0-1	Envelope 4 Repeat 0 = Off 1 = On
152	0-142	Envelope 4 Destination (see table of modulation destinations and values)

NRPN	Value	Description
155	0-254	Envelope 5 Amt 0 to 126 = -127 to -1 127 = 0 128 to 254 = 1 to 127
156	0-127	Velocity to Env 5 Amt
157	0-127	Envelope 5 Delay
158	0-127	Envelope 5 Attack
159	0-127	Envelope 5 Decay
160	0-127	Envelope 5 Sustain
161	0-127	Envelope 5 Release
162	0-1	Envelope 5 Repeat 0 = Off 1 = On
163	0-142	Envelope 5 Destination (see table of modulation destinations and values)
166	0-255	LFO 1 Frequency
167	0-15	LFO 1 Sync Setting 0 = 32nd triplet 1 = 32nd 2 = 16th triplet 3 = 16th 4 = 8th triplet 5 = 8th 6 = quarter triplet 7 = 1 quarter 8 = dotted quarter 9 = half 10 = 3 quarters 11 = 4 quarters 12 = 6 quarters 13 = 8 quarters 14 = 16 quarters 15 = 32 quarters
168	0-1	LFO 1 Sync 0 = Off 1 = On

NRPN	Value	Description
169	0-7	LFO 1 Shape 0 = triangle 1 = reverse sawtooth 2 = sawtooth 3 = square 4 = pulse 1 5 = pulse 2 6 = pulse 3 7 = random
170	0-127	LFO 1 Amount
171	0-127	LFO 1 Slew Rate
172	0-127	LFO 1 Phase
173	0-1	LFO 1 Wave Reset 0 = Off 1 = On
174	0-142	LFO 1 Destination (see table of modulation destinations and values)
176	0-255	LFO 2 Frequency
177	0-15	LFO 2 Sync Setting (see LFO 1 Sync Setting)
178	0-1	LFO 2 Sync 0 = Off 1 = On
179	0-7	LFO 2 Shape (see LFO 1 Shape)
180	0-127	LFO 2 Amount
181	0-127	LFO 2 Slew Rate
182	0-127	LFO 2 Phase
183	0-1	LFO 2 Wave Reset 0 = Off 1 = On
184	0-142	LFO 2 Destination (see table of modulation destinations and values)
186	0-255	LFO 3 Frequency
187	0-15	LFO 3 Sync Setting (see LFO 1 Sync Setting)
188	0-1	LFO 3 Sync 0 = Off 1 = On
189	0-7	LFO 3 Shape (see LFO 1 Shape)
190	0-127	LFO 3 Amount

NRPN	Value	Description
191	0-127	LFO 3 Slew Rate
192	0-127	LFO 3 Phase
193	0-1	LFO 3 Wave Reset 0 = Off 1 = On
194	0-142	LFO 3 Destination (see table of modulation destinations and values)
196	0-255	LFO 4 Frequency
197	0-15	LFO 4 Sync Setting (see LFO 1 Sync setting)
198	0-1	LFO 4 Sync 0 = Off 1 = On
199	0-7	LFO 4 Shape (see LFO 1 Shape)
200	0-127	LFO 4 Amount
201	0-127	LFO 4 Slew Rate
202	0-127	LFO 4 Phase
203	0-1	LFO 4 Wave Reset 0 = Off 1 = On
204	0-142	LFO 4 Destination (see list of modulation destinations and values)
206	0-255	Delay 1 Time
207	0-11	Delay 1 Sync Setting 0 = 64th 1 = 32nd 2 = dotted 32nd 3 = 16th 4 = dotted 16th 5 = 8th 6 = dotted 8th 7 = quarter 8 = dotted quarter 9 = half 10 = dotted half 11 = whole
208	0-1	Delay 1 Sync 0 = Off 1 = On

NRPN	Value	Description
209	0-127	Delay 1 Amount
210	0-127	Delay 1 Feedback
211	0-127	Delay 1 Lowpass Filter
212	0-127	Delay 1 Highpass Filter
213	0-127	Delay 1 Pan
216	0-255	Delay 2 Time
217	0-11	Delay 2 Sync Setting (see Delay 1 Sync Setting)
218	0-1	Delay 2 Sync 0 = Off 1 = On
219	0-127	Delay 2 Amount
220	0-127	Delay 2 Feedback
221	0-127	Delay 2 Lowpass Filter
222	0-127	Delay 2 Highpass Filter
223	0-127	Delay 2 Pan
226	0-255	Delay 3 Time
227	0-11	Delay 3 Sync Setting (see Delay 1 Sync Setting)
228	0-1	Delay 3 Sync 0 = Off 1 = On
229	0-127	Delay 3 Amount
230	0-127	Delay 3 Feedback
231	0-127	Delay 3 Lowpass Filter
232	0-127	Delay 3 Highpass Filter
233	0-127	Delay 3 Pan
236	0-255	Delay 4 Time
237	0-11	Delay 4 Sync Setting (see Delay 1 Sync Setting)
238	0-1	Delay 4 Sync 0 = Off 1 = On
239	0-127	Delay 4 Amount
240	0-127	Delay 4 Feedback
241	0-127	Delay 4 Lowpass Filter
242	0-127	Delay 4 Highpass Filter
243	0-127	Delay 4 Pan

NRPN	Value	Description
244	0-1	Delay 4 Buffer Size 0 = Small 1 = Large
246	0-51	Mod 1 Source (see table of modulation sources and values)
247	0-254	Mod 1 Amount 0 to 126 = -127 to -1 127 = 0 128 to 254 = 1 to 127
248	0-142	Mod 1 Destination (see table of modulation destinations and values)
250	0-51	Mod 2 Source (see table of modulation sources and values)
251	0-254	Mod 2 Amount 0 to 126 = -127 to -1 127 = 0 128 to 254 = 1 to 127
252	0-142	Mod 2 Destination (see table of modulation destinations and values)
254	0-51	Mod 3 Source (see table of modulation sources and values)
255	0-254	Mod 3 Amount 0 to 126 = -127 to -1 127 = 0 128 to 254 = 1 to 127
256	0-142	Mod 3 Destination (see table of modulation destinations and values)
258	0-51	Mod 4 Source (see table of modulation sources and values)
259	0-254	Mod 4 Amount 0 to 126 = -127 to -1 127 = 0 128 to 254 = 1 to 127
260	0-142	Mod 4 Destination (see table of modulation destinations and values)
262	0-51	Mod 5 Source (see table of modulation sources and values)

NRPN	Value	Description
263	0-254	Mod 5 Amount 0 to 126 = -127 to -1 127 = 0 128 to 254 = 1 to 127
264	0-142	Mod 5 Destination (see table of modulation destinations and values)
266	0-51	Mod 6 Source (see table of modulation sources and values)
267	0-254	Mod 6 Amount 0 to 126 = -127 to -1 127 = 0 128 to 254 = 1 to 127
268	0-142	Mod 6 Destination (see table of modulation destinations and values)
270	0-51	Mod 7 Source (see table of modulation sources and values)
271	0-254	Mod 7 Amount 0 to 126 = -127 to -1 127 = 0 128 to 254 = 1 to 127
272	0-142	Mod 7 Destination (see table of modulation destinations and values)
274	0-51	Mod 8 Source (see table of modulation sources and values)
275	0-254	Mod 8 Amount 0 to 126 = -127 to -1 127 = 0 128 to 254 = 1 to 127
276	0-142	Mod 8 Destination (see table of modulation destinations and values)
278	0-51	Mod 9 Source (see table of modulation sources and values)
279	0-254	Mod 9 Amount 0 to 126 = -127 to -1 127 = 0 128 to 254 = 1 to 127
280	0-142	Mod 9 Destination (see table of modulation destinations and values)

NRPN	Value	Description
282	0-51	Mod 10 Source (see table of modulation sources and values)
283	0-254	Mod 10 Amount 0 to 126 = -127 to -1 127 = 0 128 to 254 = 1 to 127
284	0-142	Mod 10 Destination (see table of modulation destinations and values)
286	0-51	Mod 11 Source (see table of modulation sources and values)
287	0-254	Mod 11 Amount 0 to 126 = -127 to -1 127 = 0 128 to 254 = 1 to 127
288	0-142	Mod 11 Destination (see table of modulation destinations and values)
290	0-51	Mod 12 Source (see table of modulation sources and values)
291	0-254	Mod 12 Amount 0 to 126 = -127 to -1 127 = 0 128 to 254 = 1 to 127
292	0-142	Mod 12 Destination (see table of modulation destinations and values)
294	0-51	Mod 13 Source (see table of modulation sources and values)
295	0-254	Mod 13 Amount 0 to 126 = -127 to -1 127 = 0 128 to 254 = 1 to 127
296	0-142	Mod 13 Destination (see table of modulation destinations and values)
298	0-51	Mod 14 Source (see table of modulation sources and values)
299	0-254	Mod 14 Amount 0 to 126 = -127 to -1 127 = 0 128 to 254 = 1 to 127

NRPN	Value	Description
300	0-142	Mod 14 Destination (see table of modulation destinations and values)
302	0-51	Mod 15 Source (see table of modulation sources and values)
303	0-254	Mod 15 Amount 0 to 126 = -127 to -1 127 = 0 128 to 254 = 1 to 127
304	0-142	Mod 15 Destination (see table of modulation destinations and values)
306	0-51	Mod 16 Source (see table of modulation sources and values)
307	0-254	Mod 16 Amount 0 to 126 = -127 to -1 127 = 0 128 to 254 = 1 to 127
308	0-142	Mod 16 Destination (see table of modulation destinations and values)
310	0-127	Quad Level
311	0-127	Audio In Level
312	0-127	Audio In Gain
313	0-127	Audio In Gate Threshold
314	0-127	Envelope Follower Attack
315	0-127	Envelope Follower Release
316	0-5	Gate Source 0 = Keyboard 1 = External Audio In 2 = CV In 1 3 = CV In 2 4 = CV In 3 5 = CV In 4
317	0-1	Envelope Retrigger 0 = Off 1 = On
318	0-3	Key Mode 0 = Low Note 1 = High Note 2 = Last Note 3 = Paraphonic

NRPN	Value	Description
320	0-1	Arpeggiator 0 = Off 1 = On
321	0-4	Arpeggiator Mode 0 = Up 1 = Down 2 = Up/Down 3 = Assign 4 = Random
322	0-2	Arpeggiator Range 0 = 1 Octave 1 = 2 Octaves 2 = 3 Octaves
323	0-10	Arp Clock Divide 0 = half 1 = quarter 2 = eighth 3 = eighth, half swing 4 = eighth, full swing 5 = eighth triplet 6 = sixteenth 7 = sixteenth, half swing 8 = sixteenth, full swing 9 = sixteenth triplet 10 = thirty-second
324	0-3	Arpeggiator Repeats
325	0-1	Arpeggiator Auto Latch 0 = Off 1 = On

NRPN	Value	Description
327	30-250	BPM
328	0-1	Sequence Length 0 = 16 steps 1 = 32 steps
329	0-2	Sequence Play Mode 0 = Normal 1 = Step 2 = Play Once
331	0-1	Sequencer 0 = Off 1 = On
332	0-6	Sequencer Play Source 0 = Sequencer 1 = Keyboard 2 = External Audio In 3 = CV In 1 4 = CV In 2 5 = CV In 3 6 = CV In 4
333	0-1	Sequencer Envelope Retrigger 0 = Off 1 = On
335	0-1	Sequencer Restart 0 = Off 1 = On
341	0-142	Track 2 Destination
342	0-142	Track 3 Destination
343	0-142	Track 4 Destination
344	0-142	Track 5 Destination
345	0-142	Track 6 Destination
346	0-142	Track 7 Destination
347	0-142	Track 8 Destination
348	0-142	Track 9 Destination
349	0-142	Track 10 Destination
350	0-142	Track 11 Destination
351	0-142	Track 12 Destination
352	0-142	Track 13 Destination
353	0-142	Track 14 Destination

NRPN	Value	Description
354	0-142	Track 15 Destination
355	0-142	Track 16 Destination
356	1-33	Track 1 Reset "Default" resets for 16- and 32-step sequences are 17 and 33, respectively.
357	1-33	Track 2 Reset (see Track 1 Reset)
358	1-33	Track 3 Reset (see Track 1 Reset)
359	1-33	Track 4 Reset (see Track 1 Reset)
360	1-33	Track 5 Reset (see Track 1 Reset)
361	1-33	Track 6 Reset (see Track 1 Reset)
362	1-33	Track 7 Reset (see Track 1 Reset)
363	1-33	Track 8 Reset (see Track 1 Reset)
364	1-33	Track 9 Reset (see Track 1 Reset)
365	1-33	Track 10 Reset (see Track 1 Reset)
366	1-33	Track 11 Reset (see Track 1 Reset)
367	1-33	Track 12 Reset (see Track 1 Reset)
368	1-33	Track 13 Reset (see Track 1 Reset)
369	1-33	Track 14 Reset (see Track 1 Reset)
370	1-33	Track 15 Reset (see Track 1 Reset)
371	1-33	Track 16 Reset (see Track 1 Reset)
372	0-127	Track 1, Step 1 Slew
373	0-127	Track 1, Step 2 Slew
374	0-127	Track 1, Step 3 Slew
375	0-127	Track 1, Step 4 Slew
376	0-127	Track 1, Step 5 Slew
377	0-127	Track 1, Step 6 Slew
378	0-127	Track 1, Step 7 Slew
379	0-127	Track 1, Step 8 Slew
380	0-127	Track 1, Step 9 Slew
381	0-127	Track 1, Step 10 Slew
382	0-127	Track 1, Step 11 Slew
383	0-127	Track 1, Step 12 Slew
384	0-127	Track 1, Step 13 Slew
385	0-127	Track 1, Step 14 Slew

NRPN	Value	Description
386	0-127	Track 1, Step 15 Slew
387	0-127	Track 1, Step 16 Slew
388	0-127	Track 1, Step 17 Slew
389	0-127	Track 1, Step 18 Slew
390	0-127	Track 1, Step 19 Slew
391	0-127	Track 1, Step 20 Slew
392	0-127	Track 1, Step 21 Slew
393	0-127	Track 1, Step 22 Slew
394	0-127	Track 1, Step 23 Slew
395	0-127	Track 1, Step 24 Slew
396	0-127	Track 1, Step 25 Slew
397	0-127	Track 1, Step 26 Slew
398	0-127	Track 1, Step 27 Slew
399	0-127	Track 1, Step 28 Slew
400	0-127	Track 1, Step 29 Slew
401	0-127	Track 1, Step 30 Slew
402	0-127	Track 1, Step 31 Slew
403	0-127	Track 1, Step 32 Slew
480	0-127	Name Character 1
481	0-127	Name Character 2
482	0-127	Name Character 3
483	0-127	Name Character 4
484	0-127	Name Character 5
485	0-127	Name Character 6
486	0-127	Name Character 7
487	0-127	Name Character 8
488	0-127	Name Character 9
489	0-127	Name Character 10
490	0-127	Name Character 11
491	0-127	Name Character 12
492	0-127	Name Character 13
493	0-127	Name Character 14
494	0-127	Name Character 15
495	0-127	Name Character 16

NRPN	Value	Description
496	0-127	Name Character 17
497	0-127	Name Character 18
498	0-127	Name Character 19
499	0-127	Name Character 20
512	0-255	Track 1, Step 1 Value
513	0-255	Track 1, Step 2 Value
514	0-255	Track 1, Step 3 Value
515	0-255	Track 1, Step 4 Value
516	0-255	Track 1, Step 5 Value
517	0-255	Track 1, Step 6 Value
518	0-255	Track 1, Step 7 Value
519	0-255	Track 1, Step 8 Value
520	0-255	Track 1, Step 9 Value
521	0-255	Track 1, Step 10 Value
522	0-255	Track 1, Step 11 Value
523	0-255	Track 1, Step 12 Value
524	0-255	Track 1, Step 13 Value
525	0-255	Track 1, Step 14 Value
526	0-255	Track 1, Step 15 Value
527	0-255	Track 1, Step 16 Value
528	0-255	Track 2, Step 1 Value
529	0-255	Track 2, Step 2 Value
530	0-255	Track 2, Step 3 Value
531	0-255	Track 2, Step 4 Value
532	0-255	Track 2, Step 5 Value
533	0-255	Track 2, Step 6 Value
534	0-255	Track 2, Step 7 Value
535	0-255	Track 2, Step 8 Value
536	0-255	Track 2, Step 9 Value
537	0-255	Track 2, Step 10 Value
538	0-255	Track 2, Step 11 Value
539	0-255	Track 2, Step 12 Value
540	0-255	Track 2, Step 13 Value
541	0-255	Track 2, Step 14 Value

NRPN	Value	Description
542	0-255	Track 2, Step 15 Value
543	0-255	Track 2, Step 16 Value
544	0-255	Track 3, Step 1 Value
545	0-255	Track 3, Step 2 Value
546	0-255	Track 3, Step 3 Value
547	0-255	Track 3, Step 4 Value
548	0-255	Track 3, Step 5 Value
549	0-255	Track 3, Step 6 Value
550	0-255	Track 3, Step 7 Value
551	0-255	Track 3, Step 8 Value
552	0-255	Track 3, Step 9 Value
553	0-255	Track 3, Step 10 Value
554	0-255	Track 3, Step 11 Value
555	0-255	Track 3, Step 12 Value
556	0-255	Track 3, Step 13 Value
557	0-255	Track 3, Step 14 Value
558	0-255	Track 3, Step 15 Value
559	0-255	Track 3, Step 16 Value
560	0-255	Track 4, Step 1 Value
561	0-255	Track 4, Step 2 Value
562	0-255	Track 4, Step 3 Value
563	0-255	Track 4, Step 4 Value
564	0-255	Track 4, Step 5 Value
565	0-255	Track 4, Step 6 Value
566	0-255	Track 4, Step 7 Value
567	0-255	Track 4, Step 8 Value
568	0-255	Track 4, Step 9 Value
569	0-255	Track 4, Step 10 Value
570	0-255	Track 4, Step 11 Value
571	0-255	Track 4, Step 12 Value
572	0-255	Track 4, Step 13 Value
573	0-255	Track 4, Step 14 Value
574	0-255	Track 4, Step 15 Value

NRPN	Value	Description
575	0-255	Track 4, Step 16 Value
576	0-255	Track 5, Step 1 Value
577	0-255	Track 5, Step 2 Value
578	0-255	Track 5, Step 3 Value
579	0-255	Track 5, Step 4 Value
580	0-255	Track 5, Step 5 Value
581	0-255	Track 5, Step 6 Value
582	0-255	Track 5, Step 7 Value
583	0-255	Track 5, Step 8 Value
584	0-255	Track 5, Step 9 Value
585	0-255	Track 5, Step 10 Value
586	0-255	Track 5, Step 11 Value
587	0-255	Track 5, Step 12 Value
588	0-255	Track 5, Step 13 Value
589	0-255	Track 5, Step 14 Value
590	0-255	Track 5, Step 15 Value
591	0-255	Track 5, Step 16 Value
592	0-255	Track 6, Step 1 Value
593	0-255	Track 6, Step 2 Value
594	0-255	Track 6, Step 3 Value
595	0-255	Track 6, Step 4 Value
596	0-255	Track 6, Step 5 Value
597	0-255	Track 6, Step 6 Value
598	0-255	Track 6, Step 7 Value
599	0-255	Track 6, Step 8 Value
600	0-255	Track 6, Step 9 Value
601	0-255	Track 6, Step 10 Value
602	0-255	Track 6, Step 11 Value
603	0-255	Track 6, Step 12 Value
604	0-255	Track 6, Step 13 Value
605	0-255	Track 6, Step 14 Value
606	0-255	Track 6, Step 15 Value
607	0-255	Track 6, Step 16 Value
608	0-255	Track 7, Step 1 Value

NRPN	Value	Description
609	0-255	Track 7, Step 2 Value
610	0-255	Track 7, Step 3 Value
611	0-255	Track 7, Step 4 Value
612	0-255	Track 7, Step 5 Value
613	0-255	Track 7, Step 6 Value
614	0-255	Track 7, Step 7 Value
615	0-255	Track 7, Step 8 Value
616	0-255	Track 7, Step 9 Value
617	0-255	Track 7, Step 10 Value
618	0-255	Track 7, Step 11 Value
619	0-255	Track 7, Step 12 Value
620	0-255	Track 7, Step 13 Value
621	0-255	Track 7, Step 14 Value
622	0-255	Track 7, Step 15 Value
623	0-255	Track 7, Step 16 Value
624	0-255	Track 8, Step 1 Value
625	0-255	Track 8, Step 2 Value
626	0-255	Track 8, Step 3 Value
627	0-255	Track 8, Step 4 Value
628	0-255	Track 8, Step 5 Value
629	0-255	Track 8, Step 6 Value
630	0-255	Track 8, Step 7 Value
631	0-255	Track 8, Step 8 Value
632	0-255	Track 8, Step 9 Value
633	0-255	Track 8, Step 10 Value
634	0-255	Track 8, Step 11 Value
635	0-255	Track 8, Step 12 Value
636	0-255	Track 8, Step 13 Value
637	0-255	Track 8, Step 14 Value
638	0-255	Track 8, Step 15 Value
639	0-255	Track 8, Step 16 Value
640	0-255	Track 1, Step 17/Track 9, Step 1
641	0-255	Track 1, Step 18/Track 9, Step 2
642	0-255	Track 1, Step 19/Track 9, Step 3

NRPN	Value	Description
643	0-255	Track 1, Step 20/Track 9, Step 4
644	0-255	Track 1, Step 21/Track 9, Step 5
645	0-255	Track 1, Step 22/Track 9, Step 6
646	0-255	Track 1, Step 23/Track 9, Step 7
647	0-255	Track 1, Step 24/Track 9, Step 8
648	0-255	Track 1, Step 25/Track 9, Step 9
649	0-255	Track 1, Step 26/Track 9, Step 10
650	0-255	Track 1, Step 27/Track 9, Step 11
651	0-255	Track 1, Step 28/Track 9, Step 12
652	0-255	Track 1, Step 29/Track 9, Step 13
653	0-255	Track 1, Step 30/Track 9, Step 14
654	0-255	Track 1, Step 31/Track 9, Step 15
655	0-255	Track 1, Step 32/Track 9, Step 16
656	0-255	Track 2, Step 17/Track 10, Step 1
657	0-255	Track 2, Step 18/Track 10, Step 2
658	0-255	Track 2, Step 19/Track 10, Step 3
659	0-255	Track 2, Step 20/Track 10, Step 4
660	0-255	Track 2, Step 21/Track 10, Step 5
661	0-255	Track 2, Step 22/Track 10, Step 6
662	0-255	Track 2, Step 23/Track 10, Step 7
663	0-255	Track 2, Step 24/Track 10, Step 8
664	0-255	Track 2, Step 25/Track 10, Step 9
665	0-255	Track 2, Step 26/Track 10, Step 10
666	0-255	Track 2, Step 27/Track 10, Step 11
667	0-255	Track 2, Step 28/Track 10, Step 12
668	0-255	Track 2, Step 29/Track 10, Step 13
669	0-255	Track 2, Step 30/Track 10, Step 14
670	0-255	Track 2, Step 31/Track 10, Step 15
671	0-255	Track 2, Step 32/Track 10, Step 16
672	0-255	Track 3, Step 17/Track 11, Step 1
673	0-255	Track 3, Step 18/Track 11, Step 2
674	0-255	Track 3, Step 19/Track 11, Step 3
675	0-255	Track 3, Step 20/Track 11, Step 4
676	0-255	Track 3, Step 21/Track 11, Step 5

NRPN	Value	Description
677	0-255	Track 3, Step 22/Track 11, Step 6
678	0-255	Track 3, Step 23/Track 11, Step 7
679	0-255	Track 3, Step 24/Track 11, Step 8
680	0-255	Track 3, Step 25/Track 11, Step 9
681	0-255	Track 3, Step 26/Track 11, Step 10
682	0-255	Track 3, Step 27/Track 11, Step 11
683	0-255	Track 3, Step 28/Track 11, Step 12
684	0-255	Track 3, Step 29/Track 11, Step 13
685	0-255	Track 3, Step 30/Track 11, Step 14
686	0-255	Track 3, Step 31/Track 11, Step 15
687	0-255	Track 3, Step 32/Track 11, Step 16
688	0-255	Track 4, Step 17/Track 12, Step 1
689	0-255	Track 4, Step 18/Track 12, Step 2
690	0-255	Track 4, Step 19/Track 12, Step 3
691	0-255	Track 4, Step 20/Track 12, Step 4
692	0-255	Track 4, Step 21/Track 12, Step 5
693	0-255	Track 4, Step 22/Track 12, Step 6
694	0-255	Track 4, Step 23/Track 12, Step 7
695	0-255	Track 4, Step 24/Track 12, Step 8
696	0-255	Track 4, Step 25/Track 12, Step 9
697	0-255	Track 4, Step 26/Track 12, Step 10
698	0-255	Track 4, Step 27/Track 12, Step 11
699	0-255	Track 4, Step 28/Track 12, Step 12
700	0-255	Track 4, Step 29/Track 12, Step 13
701	0-255	Track 4, Step 30/Track 12, Step 14
702	0-255	Track 4, Step 31/Track 12, Step 15
703	0-255	Track 4, Step 32/Track 12, Step 16
704	0-255	Track 5, Step 17/Track 13, Step 1
705	0-255	Track 5, Step 18/Track 13, Step 2
706	0-255	Track 5, Step 19/Track 13, Step 3
707	0-255	Track 5, Step 20/Track 13, Step 4
708	0-255	Track 5, Step 21/Track 13, Step 5
709	0-255	Track 5, Step 22/Track 13, Step 6
710	0-255	Track 5, Step 23/Track 13, Step 7

NRPN	Value	Description
711	0-255	Track 5, Step 24/Track 13, Step 8
712	0-255	Track 5, Step 25/Track 13, Step 9
713	0-255	Track 5, Step 26/Track 13, Step 10
714	0-255	Track 5, Step 27/Track 13, Step 11
715	0-255	Track 5, Step 28/Track 13, Step 12
716	0-255	Track 5, Step 29/Track 13, Step 13
717	0-255	Track 5, Step 30/Track 13, Step 14
718	0-255	Track 5, Step 31/Track 13, Step 15
719	0-255	Track 5, Step 32/Track 13, Step 16
720	0-255	Track 6, Step 17/Track 14, Step 1
721	0-255	Track 6, Step 18/Track 14, Step 2
722	0-255	Track 6, Step 19/Track 14, Step 3
723	0-255	Track 6, Step 20/Track 14, Step 4
724	0-255	Track 6, Step 21/Track 14, Step 5
725	0-255	Track 6, Step 22/Track 14, Step 6
726	0-255	Track 6, Step 23/Track 14, Step 7
727	0-255	Track 6, Step 24/Track 14, Step 8
728	0-255	Track 6, Step 25/Track 14, Step 9
729	0-255	Track 6, Step 26/Track 14, Step 10
730	0-255	Track 6, Step 27/Track 14, Step 11
731	0-255	Track 6, Step 28/Track 14, Step 12
732	0-255	Track 6, Step 29/Track 14, Step 13
733	0-255	Track 6, Step 30/Track 14, Step 14
734	0-255	Track 6, Step 31/Track 14, Step 15
735	0-255	Track 6, Step 32/Track 14, Step 16
736	0-255	Track 7, Step 17/Track 15, Step 1
737	0-255	Track 7, Step 18/Track 15, Step 2
738	0-255	Track 7, Step 19/Track 15, Step 3
739	0-255	Track 7, Step 20/Track 15, Step 4
740	0-255	Track 7, Step 21/Track 15, Step 5
741	0-255	Track 7, Step 22/Track 15, Step 6
742	0-255	Track 7, Step 23/Track 15, Step 7

NRPN	Value	Description
743	0-255	Track 7, Step 24/Track 15, Step 8
744	0-255	Track 7, Step 25/Track 15, Step 9
745	0-255	Track 7, Step 26/Track 15, Step 10
746	0-255	Track 7, Step 27/Track 15, Step 11
747	0-255	Track 7, Step 28/Track 15, Step 12
748	0-255	Track 7, Step 29/Track 15, Step 13
749	0-255	Track 7, Step 30/Track 15, Step 14
750	0-255	Track 7, Step 31/Track 15, Step 15
751	0-255	Track 7, Step 32/Track 15, Step 16
752	0-255	Track 8, Step 17/Track 16, Step 1
753	0-255	Track 8, Step 18/Track 16, Step 2
754	0-255	Track 8, Step 19/Track 16, Step 3
755	0-255	Track 8, Step 20/Track 16, Step 4
756	0-255	Track 8, Step 21/Track 16, Step 5
757	0-255	Track 8, Step 22/Track 16, Step 6
758	0-255	Track 8, Step 23/Track 16, Step 7
759	0-255	Track 8, Step 24/Track 16, Step 8
760	0-255	Track 8, Step 25/Track 16, Step 9
761	0-255	Track 8, Step 26/Track 16, Step 10
762	0-255	Track 8, Step 27/Track 16, Step 11
763	0-255	Track 8, Step 28/Track 16, Step 12
764	0-255	Track 8, Step 29/Track 16, Step 13
765	0-255	Track 8, Step 30/Track 16, Step 14
766	0-255	Track 8, Step 31/Track 16, Step 15
767	0-255	Track 8, Step 32/Track 16, Step 16
768	0, 128	Track 1, Step 1 Tie*
769	0, 128	Track 1, Step 2 Tie*
770	0, 128	Track 1, Step 3 Tie*
771	0, 128	Track 1, Step 4 Tie*
772	0, 128	Track 1, Step 5 Tie*
773	0, 128	Track 1, Step 6 Tie*
774	0, 128	Track 1, Step 7 Tie*

NRPN	Value	Description
775	0, 128	Track 1, Step 8 Tie*
776	0, 128	Track 1, Step 9 Tie*
777	0, 128	Track 1, Step 10 Tie*
778	0, 128	Track 1, Step 11 Tie*
779	0, 128	Track 1, Step 12 Tie*
780	0, 128	Track 1, Step 13 Tie*
781	0, 128	Track 1, Step 14 Tie*
782	0, 128	Track 1, Step 15 Tie*
783	0, 128	Track 1, Step 16 Tie*
784	0-255	Track 2, Step 1 Slew/Tie†
785	0-255	Track 2, Step 2 Slew/Tie†
786	0-255	Track 2, Step 3 Slew/Tie†
787	0-255	Track 2, Step 1 Slew/Tie†
788	0-255	Track 2, Step 4 Slew/Tie†
789	0-255	Track 2, Step 5 Slew/Tie†
790	0-255	Track 2, Step 6 Slew/Tie†
791	0-255	Track 2, Step 7 Slew/Tie†
792	0-255	Track 2, Step 8 Slew/Tie†
793	0-255	Track 2, Step 9 Slew/Tie†
794	0-255	Track 2, Step 10 Slew/Tie†
795	0-255	Track 2, Step 11 Slew/Tie†
796	0-255	Track 2, Step 12 Slew/Tie†
797	0-255	Track 2, Step 13 Slew/Tie†
798	0-255	Track 2, Step 14 Slew/Tie†
799	0-255	Track 2, Step 15 Slew/Tie†
800	0-255	Track 3, Step 1 Slew/Tie†
801	0-255	Track 3, Step 2 Slew/Tie†
802	0-255	Track 3, Step 3 Slew/Tie†
803	0-255	Track 3, Step 1 Slew/Tie†
804	0-255	Track 3, Step 4 Slew/Tie†
805	0-255	Track 3, Step 5 Slew/Tie†
806	0-255	Track 3, Step 6 Slew/Tie†
807	0-255	Track 3, Step 7 Slew/Tie†
808	0-255	Track 3, Step 8 Slew/Tie†

NRPN	Value	Description
809	0-255	Track 3, Step 9 Slew/Tie†
810	0-255	Track 3, Step 10 Slew/Tie†
811	0-255	Track 3, Step 11 Slew/Tie†
812	0-255	Track 3, Step 12 Slew/Tie†
813	0-255	Track 3, Step 13 Slew/Tie†
814	0-255	Track 3, Step 14 Slew/Tie†
815	0-255	Track 3, Step 15 Slew/Tie†
816	0-255	Track 4, Step 1 Slew/Tie†
817	0-255	Track 4, Step 2 Slew/Tie†
818	0-255	Track 4, Step 3 Slew/Tie†
819	0-255	Track 4, Step 1 Slew/Tie†
820	0-255	Track 4, Step 4 Slew/Tie†
821	0-255	Track 4, Step 5 Slew/Tie†
822	0-255	Track 4, Step 6 Slew/Tie†
823	0-255	Track 4, Step 7 Slew/Tie†
824	0-255	Track 4, Step 8 Slew/Tie†
825	0-255	Track 4, Step 9 Slew/Tie†
826	0-255	Track 4, Step 10 Slew/Tie†
827	0-255	Track 4, Step 11 Slew/Tie†
828	0-255	Track 4, Step 12 Slew/Tie†
829	0-255	Track 4, Step 13 Slew/Tie†
830	0-255	Track 4, Step 14 Slew/Tie†
831	0-255	Track 4, Step 15 Slew/Tie†
832	0-255	Track 5, Step 1 Slew/Tie†
833	0-255	Track 5, Step 2 Slew/Tie†
834	0-255	Track 5, Step 3 Slew/Tie†
835	0-255	Track 5, Step 1 Slew/Tie†
836	0-255	Track 5, Step 4 Slew/Tie†
837	0-255	Track 5, Step 5 Slew/Tie†
838	0-255	Track 5, Step 6 Slew/Tie†
839	0-255	Track 5, Step 7 Slew/Tie†
840	0-255	Track 5, Step 8 Slew/Tie†
841	0-255	Track 5, Step 9 Slew/Tie†
842	0-255	Track 5, Step 10 Slew/Tie†

NRPN	Value	Description
843	0-255	Track 5, Step 11 Slew/Tie†
844	0-255	Track 5, Step 12 Slew/Tie†
845	0-255	Track 5, Step 13 Slew/Tie†
846	0-255	Track 5, Step 14 Slew/Tie†
847	0-255	Track 5, Step 15 Slew/Tie†
848	0-255	Track 6, Step 1 Slew/Tie†
849	0-255	Track 6, Step 2 Slew/Tie†
850	0-255	Track 6, Step 3 Slew/Tie†
851	0-255	Track 6, Step 1 Slew/Tie†
852	0-255	Track 6, Step 4 Slew/Tie†
853	0-255	Track 6, Step 5 Slew/Tie†
854	0-255	Track 6, Step 6 Slew/Tie†
855	0-255	Track 6, Step 7 Slew/Tie†
856	0-255	Track 6, Step 8 Slew/Tie†
857	0-255	Track 6, Step 9 Slew/Tie†
858	0-255	Track 6, Step 10 Slew/Tie†
859	0-255	Track 6, Step 11 Slew/Tie†
860	0-255	Track 6, Step 12 Slew/Tie†
861	0-255	Track 6, Step 13 Slew/Tie†
862	0-255	Track 6, Step 14 Slew/Tie†
863	0-255	Track 6, Step 15 Slew/Tie†
864	0-255	Track 7, Step 1 Slew/Tie†
865	0-255	Track 7, Step 2 Slew/Tie†
866	0-255	Track 7, Step 3 Slew/Tie†
867	0-255	Track 7, Step 1 Slew/Tie†
868	0-255	Track 7, Step 4 Slew/Tie†
869	0-255	Track 7, Step 5 Slew/Tie†
870	0-255	Track 7, Step 6 Slew/Tie†
871	0-255	Track 7, Step 7 Slew/Tie†
872	0-255	Track 7, Step 8 Slew/Tie†
873	0-255	Track 7, Step 9 Slew/Tie†
874	0-255	Track 7, Step 10 Slew/Tie†
875	0-255	Track 7, Step 11 Slew/Tie†
876	0-255	Track 7, Step 12 Slew/Tie†

NRPN	Value	Description
877	0-255	Track 7, Step 13 Slew/Tie†
878	0-255	Track 7, Step 14 Slew/Tie†
879	0-255	Track 7, Step 15 Slew/Tie†
880	0-255	Track 8, Step 1 Slew/Tie†
881	0-255	Track 8, Step 2 Slew/Tie†
882	0-255	Track 8, Step 3 Slew/Tie†
883	0-255	Track 8, Step 1 Slew/Tie†
884	0-255	Track 8, Step 4 Slew/Tie†
885	0-255	Track 8, Step 5 Slew/Tie†
886	0-255	Track 8, Step 6 Slew/Tie†
887	0-255	Track 8, Step 7 Slew/Tie†
888	0-255	Track 8, Step 8 Slew/Tie†
889	0-255	Track 8, Step 9 Slew/Tie†
890	0-255	Track 8, Step 10 Slew/Tie†
891	0-255	Track 8, Step 11 Slew/Tie†
892	0-255	Track 8, Step 12 Slew/Tie†
893	0-255	Track 8, Step 13 Slew/Tie†
894	0-255	Track 8, Step 14 Slew/Tie†
895	0-255	Track 8, Step 15 Slew/Tie†
896	0-255	Track 1, Step 17/Track 9, Step 1 Slew/Tie†
897	0-255	Track 1, Step 18/Track 9, Step 2 Slew/Tie†
898	0-255	Track 1, Step 19/Track 9, Step 3 Slew/Tie†
899	0-255	Track 1, Step 20/Track 9, Step 4 Slew/Tie†
900	0-255	Track 1, Step 21/Track 9, Step 5 Slew/Tie†
901	0-255	Track 1, Step 22/Track 9, Step 6 Slew/Tie†
902	0-255	Track 1, Step 23/Track 9, Step 7 Slew/Tie†
903	0-255	Track 1, Step 24/Track 9, Step 8 Slew/Tie†
904	0-255	Track 1, Step 25/Track 9, Step 9 Slew/Tie†
905	0-255	Track 1, Step 26/Track 9, Step 10 Slew/Tie†
906	0-255	Track 1, Step 27/Track 9, Step 11 Slew/Tie†
907	0-255	Track 1, Step 28/Track 9, Step 12 Slew/Tie†
908	0-255	Track 1, Step 29/Track 9, Step 13 Slew/Tie†
909	0-255	Track 1, Step 30/Track 9, Step 14 Slew/Tie†
910	0-255	Track 1, Step 31/Track 9, Step 15 Slew/Tie†

NRPN	Value	Description
911	0-255	Track 1, Step 32/Track 9, Step 16 Slew/Tie†
912	0-255	Track 2, Step 17/Track 10, Step 1 Slew/Tie†
913	0-255	Track 2, Step 18/Track 10, Step 2 Slew/Tie†
914	0-255	Track 2, Step 19/Track 10, Step 3 Slew/Tie†
915	0-255	Track 2, Step 20/Track 10, Step 4 Slew/Tie†
916	0-255	Track 2, Step 21/Track 10, Step 5 Slew/Tie†
917	0-255	Track 2, Step 22/Track 10, Step 6 Slew/Tie†
918	0-255	Track 2, Step 23/Track 10, Step 7 Slew/Tie†
919	0-255	Track 2, Step 24/Track 10, Step 8 Slew/Tie†
920	0-255	Track 2, Step 25/Track 10, Step 9 Slew/Tie†
921	0-255	Track 2, Step 26/Track 10, Step 10 Slew/Tie†
922	0-255	Track 2, Step 27/Track 10, Step 11 Slew/Tie†
923	0-255	Track 2, Step 28/Track 10, Step 12 Slew/Tie†
924	0-255	Track 2, Step 29/Track 10, Step 13 Slew/Tie†
925	0-255	Track 2, Step 30/Track 10, Step 14 Slew/Tie†
926	0-255	Track 2, Step 31/Track 10, Step 15 Slew/Tie†
927	0-255	Track 2, Step 32/Track 10, Step 16 Slew/Tie†
928	0-255	Track 3, Step 17/Track 11, Step 1 Slew/Tie†
929	0-255	Track 3, Step 18/Track 11, Step 2 Slew/Tie†
930	0-255	Track 3, Step 19/Track 11, Step 3 Slew/Tie†
931	0-255	Track 3, Step 20/Track 11, Step 4 Slew/Tie†
932	0-255	Track 3, Step 21/Track 11, Step 5 Slew/Tie†
933	0-255	Track 3, Step 22/Track 11, Step 6 Slew/Tie†
934	0-255	Track 3, Step 23/Track 11, Step 7 Slew/Tie†
935	0-255	Track 3, Step 24/Track 11, Step 8 Slew/Tie†
936	0-255	Track 3, Step 25/Track 11, Step 9 Slew/Tie†
937	0-255	Track 3, Step 26/Track 11, Step 10 Slew/Tie†
938	0-255	Track 3, Step 27/Track 11, Step 11 Slew/Tie†
939	0-255	Track 3, Step 28/Track 11, Step 12 Slew/Tie†
940	0-255	Track 3, Step 29/Track 11, Step 13 Slew/Tie†
941	0-255	Track 3, Step 30/Track 11, Step 14 Slew/Tie†
942	0-255	Track 3, Step 31/Track 11, Step 15 Slew/Tie†
943	0-255	Track 3, Step 32/Track 11, Step 16 Slew/Tie†
944	0-255	Track 4, Step 17/Track 12, Step 1 Slew/Tie†

NRPN	Value	Description
945	0-255	Track 4, Step 18/Track 12, Step 2 Slew/Tie†
946	0-255	Track 4, Step 19/Track 12, Step 3 Slew/Tie†
947	0-255	Track 4, Step 20/Track 12, Step 4 Slew/Tie†
948	0-255	Track 4, Step 21/Track 12, Step 5 Slew/Tie†
949	0-255	Track 4, Step 22/Track 12, Step 6 Slew/Tie†
950	0-255	Track 4, Step 23/Track 12, Step 7 Slew/Tie†
951	0-255	Track 4, Step 24/Track 12, Step 8 Slew/Tie†
952	0-255	Track 4, Step 25/Track 12, Step 9 Slew/Tie†
953	0-255	Track 4, Step 26/Track 12, Step 10 Slew/Tie†
954	0-255	Track 4, Step 27/Track 12, Step 11 Slew/Tie†
955	0-255	Track 4, Step 28/Track 12, Step 12 Slew/Tie†
956	0-255	Track 4, Step 29/Track 12, Step 13 Slew/Tie†
957	0-255	Track 4, Step 30/Track 12, Step 14 Slew/Tie†
958	0-255	Track 4, Step 31/Track 12, Step 15 Slew/Tie†
959	0-255	Track 4, Step 32/Track 12, Step 16 Slew/Tie†
960	0-255	Track 5, Step 17/Track 13, Step 1 Slew/Tie†
961	0-255	Track 5, Step 18/Track 13, Step 2 Slew/Tie†
962	0-255	Track 5, Step 19/Track 13, Step 3 Slew/Tie†
963	0-255	Track 5, Step 20/Track 13, Step 4 Slew/Tie†
964	0-255	Track 5, Step 21/Track 13, Step 5 Slew/Tie†
965	0-255	Track 5, Step 22/Track 13, Step 6 Slew/Tie†
966	0-255	Track 5, Step 23/Track 13, Step 7 Slew/Tie†
967	0-255	Track 5, Step 24/Track 13, Step 8 Slew/Tie†
968	0-255	Track 5, Step 25/Track 13, Step 9 Slew/Tie†
969	0-255	Track 5, Step 26/Track 13, Step 10 Slew/Tie†
970	0-255	Track 5, Step 27/Track 13, Step 11 Slew/Tie†
971	0-255	Track 5, Step 28/Track 13, Step 12 Slew/Tie†
972	0-255	Track 5, Step 29/Track 13, Step 13 Slew/Tie†
973	0-255	Track 5, Step 30/Track 13, Step 14 Slew/Tie†
974	0-255	Track 5, Step 31/Track 13, Step 15 Slew/Tie†
975	0-255	Track 5, Step 32/Track 13, Step 16 Slew/Tie†
976	0-255	Track 6, Step 17/Track 14, Step 1 Slew/Tie†
977	0-255	Track 6, Step 18/Track 14, Step 2 Slew/Tie†
978	0-255	Track 6, Step 19/Track 14, Step 3 Slew/Tie†

NRPN	Value	Description
979	0-255	Track 6, Step 20/Track 14, Step 4 Slew/Tie†
980	0-255	Track 6, Step 21/Track 14, Step 5 Slew/Tie†
981	0-255	Track 6, Step 22/Track 14, Step 6 Slew/Tie†
982	0-255	Track 6, Step 23/Track 14, Step 7 Slew/Tie†
983	0-255	Track 6, Step 24/Track 14, Step 8 Slew/Tie†
984	0-255	Track 6, Step 25/Track 14, Step 9 Slew/Tie†
985	0-255	Track 6, Step 26/Track 14, Step 10 Slew/Tie†
986	0-255	Track 6, Step 27/Track 14, Step 11 Slew/Tie†
987	0-255	Track 6, Step 28/Track 14, Step 12 Slew/Tie†
988	0-255	Track 6, Step 29/Track 14, Step 13 Slew/Tie†
989	0-255	Track 6, Step 30/Track 14, Step 14 Slew/Tie†
990	0-255	Track 6, Step 31/Track 14, Step 15 Slew/Tie†
991	0-255	Track 6, Step 32/Track 14, Step 16 Slew/Tie†
992	0-255	Track 7, Step 17/Track 15, Step 1 Slew/Tie†
993	0-255	Track 7, Step 18/Track 15, Step 2 Slew/Tie†
994	0-255	Track 7, Step 19/Track 15, Step 3 Slew/Tie†
995	0-255	Track 7, Step 20/Track 15, Step 4 Slew/Tie†
996	0-255	Track 7, Step 21/Track 15, Step 5 Slew/Tie†
997	0-255	Track 7, Step 22/Track 15, Step 6 Slew/Tie†
998	0-255	Track 7, Step 23/Track 15, Step 7 Slew/Tie†
999	0-255	Track 7, Step 24/Track 15, Step 8 Slew/Tie†
1000	0-255	Track 7, Step 25/Track 15, Step 9 Slew/Tie†
1001	0-255	Track 7, Step 26/Track 15, Step 10 Slew/Tie†
1002	0-255	Track 7, Step 27/Track 15, Step 11 Slew/Tie†
1003	0-255	Track 7, Step 28/Track 15, Step 12 Slew/Tie†
1004	0-255	Track 7, Step 29/Track 15, Step 13 Slew/Tie†
1005	0-255	Track 7, Step 30/Track 15, Step 14 Slew/Tie†
1006	0-255	Track 7, Step 31/Track 15, Step 15 Slew/Tie†
1007	0-255	Track 7, Step 32/Track 15, Step 16 Slew/Tie†
1008	0-255	Track 8, Step 17/Track 16, Step 1 Slew/Tie†
1009	0-255	Track 8, Step 18/Track 16, Step 2 Slew/Tie†
1010	0-255	Track 8, Step 19/Track 16, Step 3 Slew/Tie†
1011	0-255	Track 8, Step 20/Track 16, Step 4 Slew/Tie†
1012	0-255	Track 8, Step 21/Track 16, Step 5 Slew/Tie†

NRPN	Value	Description
1013	0-255	Track 8, Step 22/Track 16, Step 6 Slew/Tie†
1014	0-255	Track 8, Step 23/Track 16, Step 7 Slew/Tie†
1015	0-255	Track 8, Step 24/Track 16, Step 8 Slew/Tie†
1016	0-255	Track 8, Step 25/Track 16, Step 9 Slew/Tie†
1017	0-255	Track 8, Step 26/Track 16, Step 10 Slew/Tie†
1018	0-255	Track 8, Step 27/Track 16, Step 11 Slew/Tie†
1019	0-255	Track 8, Step 28/Track 16, Step 12 Slew/Tie†
1020	0-255	Track 8, Step 29/Track 16, Step 13 Slew/Tie†
1021	0-255	Track 8, Step 30/Track 16, Step 14 Slew/Tie†
1022	0-255	Track 8, Step 31/Track 16, Step 15 Slew/Tie†
1023	0-255	Track 8, Step 32/Track 16, Step 16 Slew/Tie†

*Set bit 8 high to turn on Tie.

†The first 7 bits set the slew value, 0 - 127. Set bit 8 high to turn on Tie.

The table below shows the allowed Name Characters and their values (ASCII code).

ASCII	32	33	34	35	36	37	38	39	40	41	43	44
Character		!	"	#	\$	%	&	'	()	+	,
ASCII	45	46	48	49	50	51	52	53	54	55	56	57
Character			0	1	2	3	4	5	6	7	8	9
ASCII	59	61	63	64	65	66	67	68	69	70	71	72
Character	;	=	?	@	A	B	C	D	E	F	G	H
ASCII	73	74	75	76	77	78	79	80	81	82	83	84
Character	I	J	K	L	M	N	O	P	Q	R	S	T
ASCII	85	86	87	88	89	90	91	93	94	95	96	97
Character	U	V	W	X	Y	Z	[]	^	_	`	a
ASCII	98	99	100	101	102	103	104	105	106	107	108	109
Character	b	c	d	e	f	g	h	i	j	k	l	m
ASCII	110	111	112	113	114	115	116	117	118	119	120	121
Character	n	o	p	q	r	s	t	u	v	w	x	y
ASCII	122	123	125									
Character	z	{	}									

The following tables list the values used with the program parameters to specify modulation sources and destinations.

Mod Source	Value
Off	0
Osc 1	1
Osc 2	2
Osc 3	3
Osc 4	4
LFO 1	5
LFO 2	6
LFO 3	7
LFO 4	8
F1 Env	9
F2 Env	10
VCA Env	11
Env 4	12
Env 5	13
Pitchbend	14
Mod Wheel	15
Slider 1 Position	16
Slider 2 Position	17
Slider 1 Pressure	18
Slider 2 Pressure	19
Aftertouch	20
Breath; CC#2	21
Foot Pedal; CC#4	22
Expression; CC#11	23
Velocity	24
Note Number	25
Random	26
DC	27
Audio Out	28
Ext Audio In	29
Envelope Follower	30

Mod Source	Value
Peak Hold	31
CV Input 1	32
CV Input 2	33
CV Input 3	34
CV Input 4	35
Seq Track 1	36
Seq Track 2	37
Seq Track 3	38
Seq Track 4	39
Seq Track 5	40
Seq Track 6	41
Seq Track 7	42
Seq Track 8	43
Seq Track 9	44
Seq Track 10	45
Seq Track 11	46
Seq Track 12	47
Seq Track 13	48
Seq Track 14	49
Seq Track 15	50
Seq Track 16	51

Mod Destination	Value
Off	0
Osc 1 Freq	1
Osc 2 Freq	2
Osc 3 Freq	3
Osc 4 Freq	4
Osc All Freq	5
Osc 1 Level	6
Osc 2 Level	7
Osc 3 Level	8
Osc 4 Level	9
Osc 1 Shape Mod	10
Osc 2 Shape Mod	11
Osc 3 Shape Mod	12
Osc 4 Shape Mod	13
Sub Osc Level	14
Osc 1 FM	15
Osc 2 FM	16
Osc 3 FM	17
Osc 4 FM	18
Osc All FM	19
Osc 1 AM	20
Osc 2 AM	21
Osc 3 AM	22
Osc 4 AM	23
Osc All AM	24
Osc All Slop	25
Air	26
Girth	27
Hack	28
Decimate	29
Drive	30
F1 Cutoff	31
F1 Resonance	32
F2 Cutoff	33

Mod Destination	Value
F2 Resonance	34
VCA	35
Pan	36
Distortion	37
Feedback Amount	38
Feedback Tuning	39
Delay 1 Amount	40
Delay 2 Amount	41
Delay 3 Amount	42
Delay 4 Amount	43
Delay 1 Time	44
Delay 2 Time	45
Delay 3 Time	46
Delay 4 Time	47
Delay 1 Feedback	48
Delay 2 Feedback	49
Delay 3 Feedback	50
Delay 4 Feedback	51
Delay 1 Pan	52
Delay 2 Pan	53
Delay 3 Pan	54
Delay 4 Pan	55
LFO 1 Freq	56
LFO 2 Freq	57
LFO 3 Freq	58
LFO 4 Freq	59
LFO 1 Amount	60
LFO 2 Amount	61
LFO 3 Amount	62
LFO 4 Amount	63
F1 Env Amount	64
F2 Env Amount	65
Amp Env Amount	66
Env 4 Amount	67

Mod Destination	Value
Env 5 Amount	68
F1 Env Attack	69
F2 Env Attack	70
Amp Env Attack	71
Env 4 Attack	72
Env 5 Attack	73
All Env Attack	74
F1 Env Decay	75
F2 Env Decay	76
Amp Env Decay	77
Env 4 Decay	78
Env 5 Decay	79
All Env Decay	80
F1 Env Release	81
F2 Env Release	82
Amp Env Release	83
Env 4 Release	84
Env 5 Release	85
All Env Release	86
Mod 1 Amount	87
Mod 2 Amount	88
Mod 3 Amount	89
Mod 4 Amount	90
Mod 5 Amount	91
Mod 6 Amount	92
Mod 7 Amount	93
Mod 8 Amount	94
Mod 9 Amount	95
Mod 10 Amount	96
Mod 11 Amount	97
Mod 12 Amount	98
Mod 13 Amount	99
Mod 14 Amount	100
Mod 15 Amount	101

Mod Destination	Value
Mod 16 Amount	102
Ext CV Out 1	103
Ext CV Out 2	104
Ext CV Out 3	105
Ext CV Out 4	106
Seq Out 1 Ch 1	107
Seq Out 1 Ch 2	108
Seq Out 1 Ch 3	109
Seq Out 1 Ch 4	110
Seq Out 1 Ch 5	111
Seq Out 1 Ch 6	112
Seq Out 1 Ch 7	113
Seq Out 1 Ch 8	114
Seq Out 1 Ch 9	115
Seq Out 1 Ch 10	116
Seq Out 1 Ch 11	117
Seq Out 1 Ch 12	118
Seq Out 1 Ch 13	119
Seq Out 1 Ch 14	120
Seq Out 1 Ch 15	121
Seq Out 1 Ch 16	122
Seq Out 2 Ch 1	123
Seq Out 2 Ch 2	124
Seq Out 2 Ch 3	125
Seq Out 2 Ch 4	126
Seq Out 2 Ch 5	127
Seq Out 2 Ch 6	128
Seq Out 2 Ch 7	129
Seq Out 2 Ch 8	130
Seq Out 2 Ch 9	131
Seq Out 2 Ch 10	132
Seq Out 2 Ch 11	133
Seq Out 2 Ch 12	134
Seq Out 2 Ch 13	135

Mod Destination	Value
Seq Out 2 Ch 14	136
Seq Out 2 Ch 15	137
Seq Out 2 Ch 16	138

Sysex Messages

Universal System Exclusive Message (Device Inquiry)

Status	Description
1111 0000	System Exclusive (SysEx)
0111 1110	Non-realtime message
0vvv vvvv	If MIDI channel is set to 1 - 16, 0vvvvvvv must match (unless MIDI Channel = ALL); always responds if 0vvvvvvv = 0111 1111.
0000 0110	Inquiry Message
0000 0001	Inquiry Request
1111 0111	End of Exclusive (EOX)

The Pro 2 responds with:

Status	Description
1111 0000	System Exclusive (SysEx)
0111 1110	Non-realtime message
0vvv vvvv	If MIDI Channel = ALL, 0vvvvvvv = 0111 1111. Otherwise 0vvvvvvv = Channel Number 0 - 15.
0000 0110	Inquiry Message
0000 0010	Inquiry Reply
0000 0001	DSI ID
0010 1100	Pro 2 ID (Family LS)
0000 0001	Family MS
0000 0000	Family Member LS
0000 0000	Family Member MS
0jjj nnnn	Main Software version: jjj - Minor rev; nnnn - Major rev
1111 0111	End of Exclusive (EOX)

Request Program Dump

Status	Description
1111 0000	System Exclusive (SysEx)
0000 0001	DSI ID
0010 1100	Pro 2 ID
0000 0101	Request Program Transmit
0000 00vv	Bank Number, 0 - 7
0vvv vvvv	Program Number, 0 - 98
1111 0111	End of Exclusive (EOX)

The Pro 2 will respond by sending out the Program Data in the format described below in *Program Data Dump*.

Request Program Edit Buffer Dump

Status	Description
1111 0000	System Exclusive (SysEx)
0000 0001	DSI ID
0010 1100	Pro 2 ID
0000 0110	Request Program Edit Buffer Transmit
1111 0111	End of Exclusive (EOX)

Pro 2 will respond by sending out the current Program edit buffer in the format described below in Program Edit Buffer Data Dump.

Request Global Parameter Dump

Status	Description
1111 0000	System Exclusive (SysEx)
0000 0001	DSI ID
0010 1100	Pro 2 ID
0000 1110	Request Global Parameter Transmit
1111 0111	End of Exclusive (EOX)

Pro 2 will respond by sending out the current values of Global Parameters in the format described in *Global Parameters Data Dump*.

Program Data Dump

Status	Description
1111 0000	System Exclusive (SysEx)
0000 0001	DSI ID
0010 1100	Pro 2 ID
0000 0010	Program Data
0000 00vv	Bank Number: 0 - 7
0vvv vvvv	Program Number: 0 - 98
0vvv vvvv	1024 bytes expanded to 1171 MIDI bytes in "packed MS bit" format
1111 0111	End of Exclusive (EOX)

Program Edit Buffer Data Dump

Status	Description
1111 0000	System Exclusive (SysEx)
0000 0001	DSI ID
0010 1100	Pro 2 ID
0000 0011	Edit Buffer Data
0vvv vvvv	1024 bytes expanded to 1171 MIDI bytes in "packed MS bit" format
1111 0111	End of Exclusive (EOX)

Global Parameters Data Dump

Value	Description
1111 0000	System Exclusive (SysEx)
0000 0001	DSI ID
0010 1100	Pro 2 ID
0000 1111	Main Parameter Data
0vvv vvvv	50 nibbles (LS then MS) for 25 Global parameters
1111 0111	End of Exclusive (EOX)



The Global Parameters Data Dump is not recognized when received; it is only transmitted when requested. NRPN messages are used to change Globals.

Packed Data Format

Data is packed in 8 byte “packets”, with the MS bit stripped from 7 parameter bytes, and packed into an eighth byte, which is sent at the start of the 8 byte packet.

Example:

Input Data

```
1 A7 A6 A5 A4 A3 A2 A1 A0
2 B7 B6 B5 B4 B3 B2 B1 B0
3 C7 C6 C5 C4 C3 C2 C1 C0
4 D7 D6 D5 D4 D3 D2 D1 D0
5 E7 E6 E5 E4 E3 E2 E1 E0
6 F7 F6 F5 F4 F3 F2 F1 F0
7 G7 G6 G5 G4 G3 G2 G1 G0
```

Packed MIDI data

```
1 00 G7 F7 E7 D7 C7 B7 A7
2 00 A6 A5 A4 A3 A2 A1 A0
3 00 B6 B5 B4 B3 B2 B1 B0
4 00 C6 C5 C4 C3 C2 C1 C0
5 00 D6 D5 D4 D3 D2 D1 D0
6 00 E6 E5 E4 E3 E2 E1 E0
7 00 F6 F5 F4 F3 F2 F1 F0
8 00 G6 G5 G4 G3 G2 G1 G0
```

This explains why it takes 1171 MIDI bytes to transmit 1024 Program data bytes.

Appendix E: Support

Troubleshooting

Here are a few suggestions for resolving problems that may occur.

The sequencer or arpeggiator has stopped running.

Check the Clock settings in the Global menu to ensure the Pro 2 is set to Master or, if set to Slave, make sure the Pro 2 is receiving MIDI clock.

Some of the programs sound different than before.

Check the Mod Wheel position. The Mod Wheel can do a lot more than just add vibrato. Also, check the Clock settings in the Global menu to ensure the Pro 2 is set to Master or, if set to Slave, make sure the Pro 2 is receiving MIDI clock.

There is a ground hum in the audio output.

USB can cause ground loops, so try to resolve any grounding issues between the computer and the Pro 2. Or use MIDI, which is opto-isolated.

The Pro 2 is behaving erratically.

This is almost always caused by a MIDI data loop. Make sure that any MIDI Thru functionality is turned off on the MIDI interface/hardware or in the MIDI software application (sequencer or whatever). Disconnect all the Pro 2's MIDI connections—MIDI and USB cables—and see if the problem persists. You can also monitor the MIDI traffic with MIDI Monitor (Mac OS) or MIDI-OX (Windows) to see if the Pro 2 is being overrun with duplicate messages.

The Pro 2 doesn't seem to respond to its controls.

Make sure Show is not on. If the synth seems to be responding normally, but doesn't make sound, make sure Local Control is on in the Global menu.

MIDI System Exclusive data is not be transmitted/received.

Check the SysEx settings in the Global menu.

The Pro 2 plays out of tune.

Check Master Coarse Tune and Master Fine Tune in the Global menu. If that seems correct, run Calibrate Wheels in the Global menu.

The touch sliders don't go full range.

Run Calibrate Sliders in the Global Menu.

A filter sounds strange or out of tune.

Run Autotune Filters in the Global menu.



It is not necessary to run any of the calibration routines on a regular basis. You should only run it if you are experiencing problems.

Still experiencing a problem with the Pro 2? Reset Globals in the Global menu.

Contacting Technical Support

If you are still having a problem with the Pro 2, contact Technical Support at support@davesmithinstruments.com. Please include your Pro 2's serial number, the version of the operating system (displayed in the Global screen), and the purchase date.



If you have not already reset the Global parameters and run the calibration routines (see Troubleshooting, above), you should do it before contacting Technical Support. It's probably the first thing they'll ask you to do.

Warranty Repair

Dave Smith Instruments warrants that the Pro 2 will be free from defects in materials and/or workmanship for 1 year from the date of purchase. Please register your product online at www.davesmithinstruments.com to establish the date of purchase. (This is not a requirement for warranty service, but it will help expedite the process.)

Please contact support@davesmithinstruments.com to determine the best course of action for getting your Pro 2 repaired. For your own protection, as well as ours, please do not return any product to Dave Smith Instruments without a return authorization (RA) number. To issue an RA number, Technical Support needs:

- Your name
- Your return address
- Your email address
- A phone number where you can be reached
- Your Pro 2's serial number
- The date of purchase and where purchased

If you need to return your instrument for repair, you are responsible for getting it to DSI. We highly recommend insuring it and packing in the original packaging. Damage resulting from shipping a product with insufficient packaging is not covered by warranty.

Dave Smith Instruments LLC
1527 Stockton Street, 3rd Floor
San Francisco, CA 94133
USA

www.davesmithinstruments.com

DSI-979R