

ELECTRONIC KEYBOARD

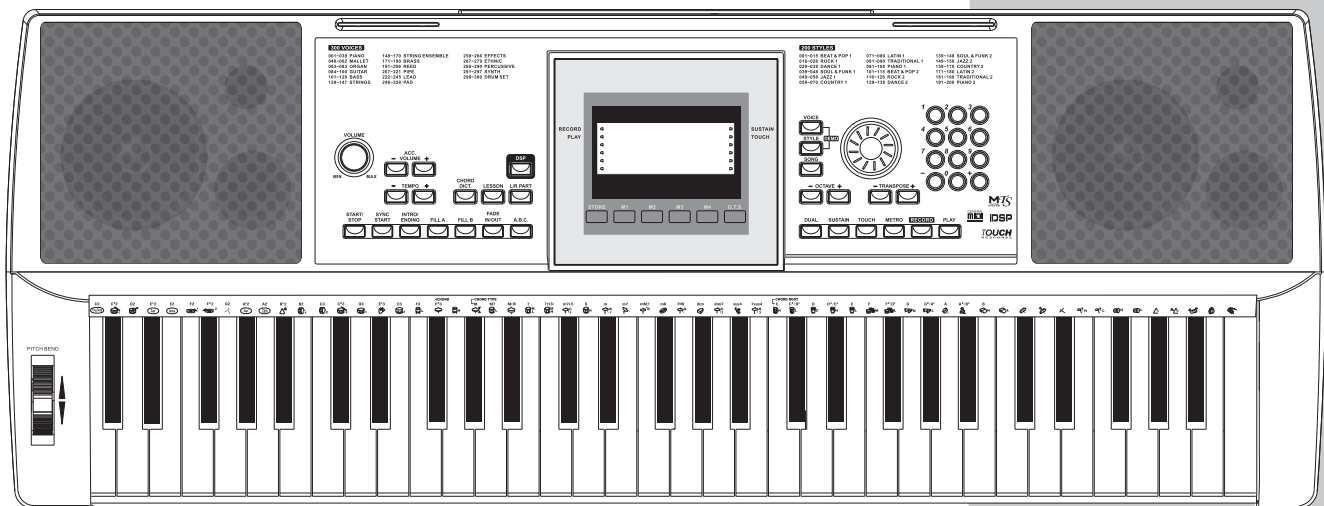

Owner's Manual

INFORMATION FOR YOUR SAFETY!

THE FCC REGULATION WARNING (for USA)

This equipment has been tested and found to comply with the limits for a Class B digital device, pursuant to Part 15 of the FCC Rules.

These limits are designed to provide reasonable protection against harmful interference in a residential installation. This equipment generates, uses, and can radiate radio frequency energy and, if not installed and used in accordance with the instructions, may cause harmful interference to radio communications. However, there is no guarantee that interference will not occur in a particular installation. If this equipment does cause harmful interference to radio or television reception, which can be determined by turning the equipment off and on, the user is encouraged to try to correct the interference by one or more of the following measures:

- Reorient or relocate the receiving antenna.
- Increase the separation between the equipment and receiver.
- Connect the equipment into an outlet on a circuit different from that to which the receiver is connected.
- Consult the dealer or an experienced radio/TV technician for help.

Unauthorized changes or modification to this system can void the user's authority to operate this equipment.

CAUTION

The normal function of the product may be disturbed by Strong Electro Magnetic Interference. If so, simply reset the product to resume normal operation by following the owner's manual. In case the function could not resume, please use the product in other location.

PRECAUTIONS

PLEASE READ CAREFULLY BEFORE PROCEEDING

Please keep this manual in a safe place for future reference.

Power Supply

Please connect the designated AC adaptor to an AC outlet of the correct voltage.

Do not connect it to an AC outlet of voltage other than that for which your instrument is intended.

Unplug the AC power adaptor when not using the instrument, or during electrical storms.

Connections

Before connecting the instrument to other devices, turn off the power to all units. This will help prevent malfunction and / or damage to other devices.

Location

Do not expose the instrument to the following conditions to avoid deformation, discoloration, or more serious damage:

- Direct sunlight
- Extreme temperature or humidity
- Excessive dusty or dirty location
- Strong vibrations or shocks
- Close to magnetic fields

Interference with other electrical devices

Radios and televisions placed nearby may experience reception interference. Operate this unit at a suitable distance from radios and televisions.

Cleaning

Clean only with a soft, dry cloth. Do not use paint thinners, solvents, cleaning fluids, or chemical-impregnated wiping cloths.

Handling

Do not apply excessive force to the switches or controls.

Do not let paper, metallic, or other objects into the instrument. If this happens, unplug the AC adaptor from the wall outlet. Then have the instrument inspected by qualified service personnel.

Disconnect all cables before moving the instrument.

Panel & Display Description	
Front Panel.....	4
Rear Panel.....	4
Display.....	5
Setup	
Power Supply.....	6
Connections	
Connecting a Footswitch.....	7
Connecting a pair of Headphones.....	7
Connecting an Audio Equipment.....	7
Connecting a Microphone.....	7
Connecting a Computer.....	7
Playing the Demos	8
Playing the Voices	
Selecting a Voice.....	8
Playing Two Voice Simultaneously-DUAL.....	8
Touch.....	9
Sustain.....	9
Pitch Bend Wheel.....	9
DSP Effect.....	9
Transpose.....	10
Octave.....	10
Playing the Styles	
Selecting a style.....	11
Playing a Fill.....	11
Intro/Ending.....	11
Sync Start.....	12
Fade In/Out.....	12
Accompaniment Volume.....	12
Tempo.....	12
Auto Bass Chord.....	13
One Touch Setting.....	14
Memory	
Memory.....	15
Chord Dictionary	15
Metronome	
Turning on the Metronome.....	16
Selecting the Beat.....	16
Playing the Songs	
Listening to the Songs.....	17
Lesson Mode.....	17
Recording and Playback	18
MIDI Functions	
What's MIDI?.....	19
MIDI Terminals.....	19
Trouble Shooting	20
Specifications	20
Appendices	
Voice List.....	21
Style List.....	23
Song List.....	25
Chord List.....	26
MIDI Implementation Chart.....	27

Panel & Display Description

Front Panel

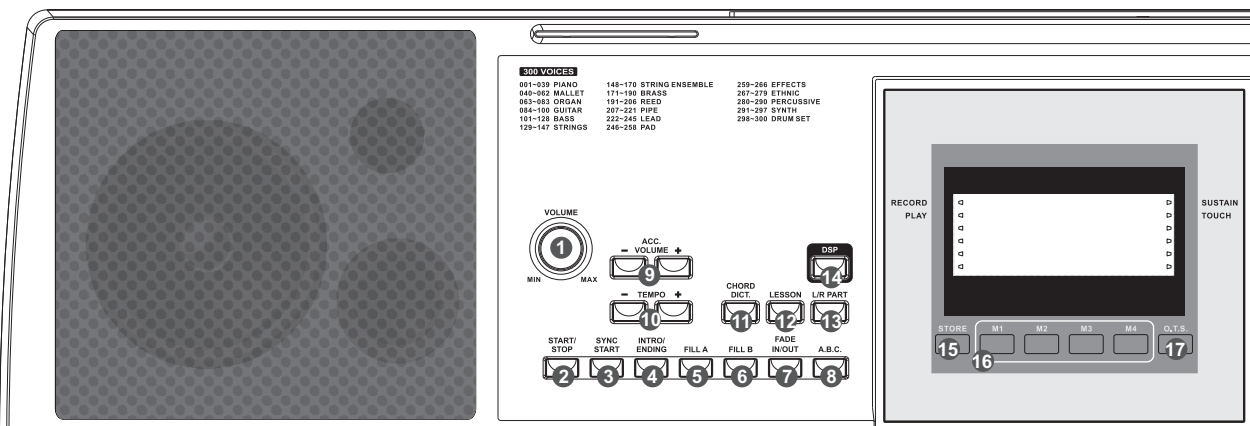

- 1. MASTER VOLUME**
Adjust the master volume.
- 2. START/STOP**
Start or stop playing the song in Song Mode.
Start or stop playing the style in Style Mode.
- 3. SYNC START**
Turn the SYNC START on and off.
- 4. INTRO/ENDING**
Play the Intro or Ending.
- 5. FILL A/MAIN A**
Play the Fill-in, and change to MAIN A.
- 6. FILL B/MAIN B**
Play the Fill-in and change to MAIN B.
- 7. FADE IN/OUT**
Turn the Fade In or Fade Out on.
- 8. A.B.C.**
Turn the Auto Bass Chord on and off.
- 9. ACC.VOL**
Adjust the accompaniment volume.
- 10. TEMPO**
Adjust the current tempo.
- 11. CHORD DICT.**
Enter the Chord Dictionary.
- 12. LESSON**
Change the Lesson Mode.
- 13. L/R PART**
Change the left and right hand in Lesson Mode.
- 14. DSP**
Turn the DSP effect on and off.
- 15. STORE**
Register the memory.
- 16. M1-M4**
Recall the memory settings.
- 17. O.T.S.**
Enter the One Touch Setting Mode.
- 31. PITCH BEND**
Bend notes up or down.

Rear Panel

- 32. DC IN**
Connect DC IN power adaptor (optional).
- 33. POWER ON/OFF**
Turn the power on and off.
- 34. AUDIO OUT**
Connect the audio equipment.
- 35. PHONE**
Connect a pair of headphones.
- 36. MIC**
Connect a microphone.
- 37. SUSTAIN**
Connect a sustain pedal.
- 38. USB**
Connect to a computer

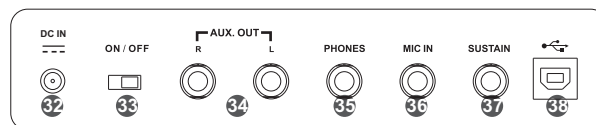

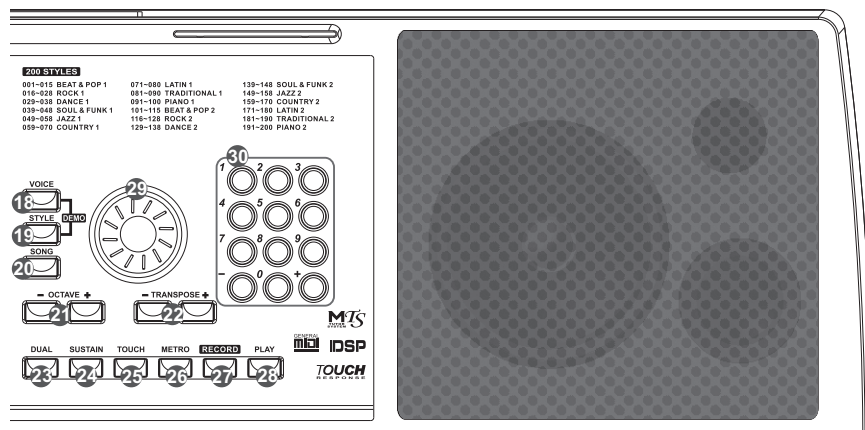

- | | | |
|---|---|---|
| <p>18. VOICE
Enter the Voice Mode.</p> <p>19. STYLE
Enter the Style Mode.</p> <p>DEMO
Enter the Demo Mode.</p> <p>20. SONG
Enter the Song Mode.</p> <p>21. OCTAVE
Adjust the Octave value.</p> <p>22. TRANSPOSE
Adjust the Transpose value.</p> | <p>23. DUAL
Turn the Voice R2 on and off.</p> <p>24. SUSTAIN
Turn the Sustain effect on and off.</p> <p>25. TOUCH
Turn the Touch response on and off.</p> <p>26. METRO
Turn the metronome on and off.</p> <p>27. RECORD
Enter the Record Mode.</p> | <p>28. PLAY
Play back the recorded performance.</p> <p>29. DATA DIAL
Increase and decrease the value.</p> <p>30. +,-,NUMBER KEYS
Select the number or adjust the parameters.</p> |
|---|---|---|

Display

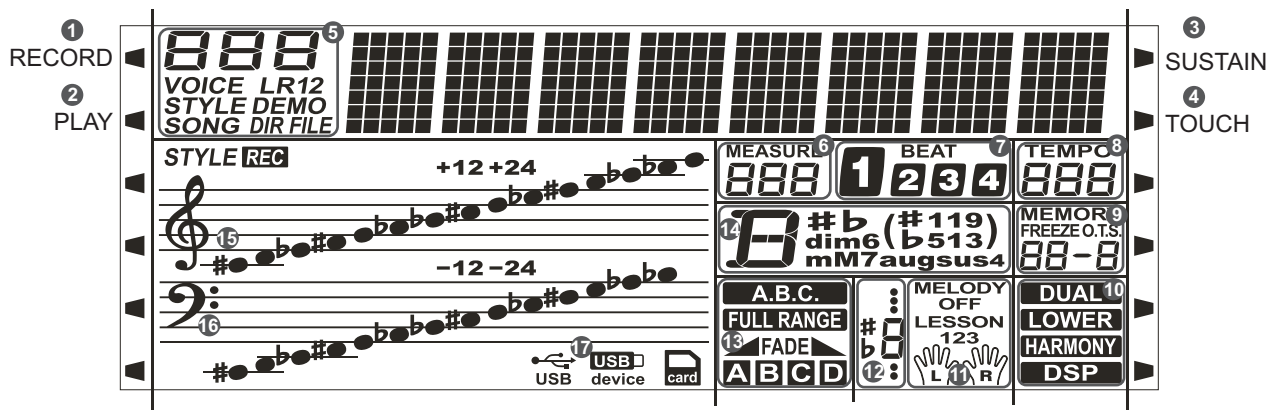

- | | | |
|---|--|--|
| <p>1. RECORD</p> <p>2. PLAY</p> <p>3. SUSTAIN</p> <p>4. TOUCH</p> <p>5. VOICE/STYLE/DEMO/SONG</p> <p>6. MEASURE</p> | <p>7. BEAT</p> <p>8. TEMPO</p> <p>9. STROE M1-M4/ONE TOUCH SETTING</p> <p>10. DUAL/DSP</p> <p>11. LEFT/RIGHT HAND LESSON MODE</p> <p>12. NOTE INDICATION</p> | <p>13. A.B.C./FADE/A/B</p> <p>14. CHORD</p> <p>15. TREBLE CLEF</p> <p>16. BASS CLEF</p> <p>17. USB</p> |
|---|--|--|

Setup

This section contains information about setting up your instrument and preparing to play. Please go through this section carefully before turning the power on.

Power Supply

You can power the unit either by batteries or by power adaptor. Follow the instructions described below.

Using Batteries

6 pieces of AA size (SUM-3 or Lr6) or equivalent alkaline batteries must first be installed into the battery compartment.

1. Open the battery compartment cover located on the bottom cabin of the unit.
2. Insert the batteries, carefully follow the polarity markings on the cabinet.
3. Replace the compartment cover, making sure that it locks firmly in place.

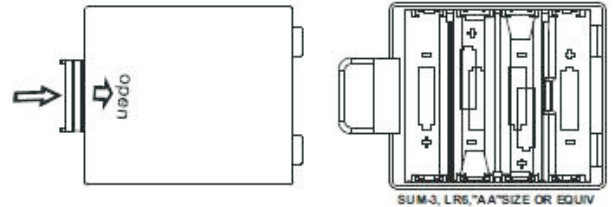

Caution:

Do not mix old and new batteries.
Always use same types of batteries.
Always remove the batteries from the unit when it is not being used for an extended period of time.

Using Power Adapter

1. First, please make sure that POWER ON/OFF switch of the instrument is set to OFF.
2. Connect the AC adaptor to the power supply jack.
3. Plug the AC adaptor into an AC outlet. And when turning the power OFF, simply reverse the procedure please. This will automatically cut off the battery power supply.
4. Turn the power ON.

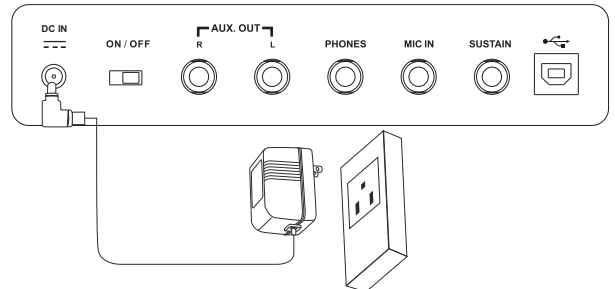

Note:

When the keyboard is not in use or in the time of thunderstorm, please disconnect the power for safety purpose.

Connecting a Footswitch

An optional footswitch can be plugged into the sustain jack and be used to switch sustain on or off. Simply by pressing a sustain footswitch, you will have a natural sustain as you play.

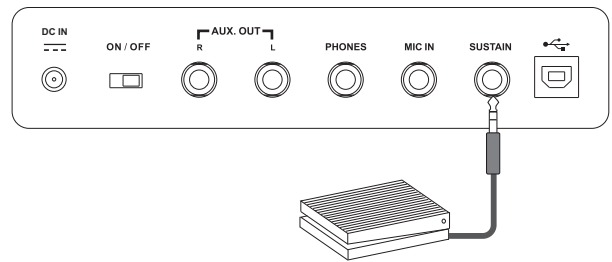

Connecting a pair of Headphones

A standard pair of stereo headphones can be connected to the PHONES jack for private practice or late-night playing. The internal stereo speaker system is automatically shut off when a pair of headphones is plugged into this jack.

Note:

Do not listen with the headphones at high volume for long periods of time. Doing so may cause hearing loss.

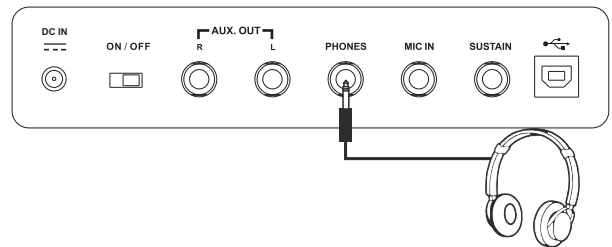

Connecting an Audio Equipment

Plug an audio cord into the AUDIO OUT jack. Then plug the other end of the cord into AUX IN of the amplifier.

Note:

To avoid damaging the speakers, please ensure that the volume has been set to the minimum level before connecting the power and other devices.

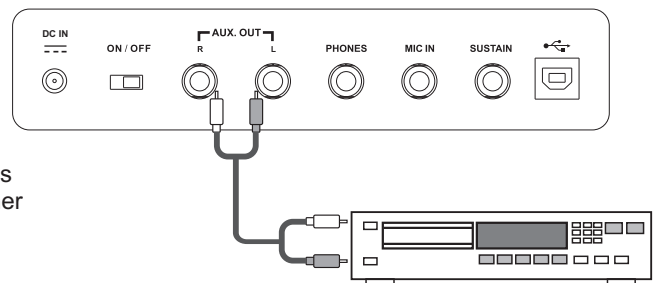

Connecting a Microphone

You can connect an external microphone to MIC IN jack.

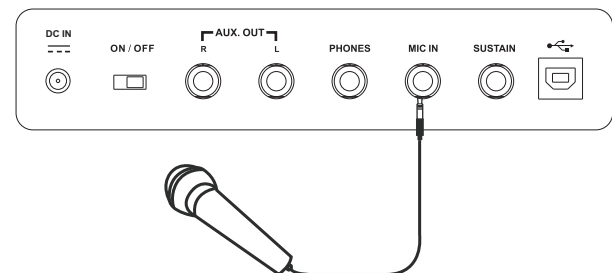

Connecting a Computer

The instrument receives and transmits MIDI messages via the USB connector.

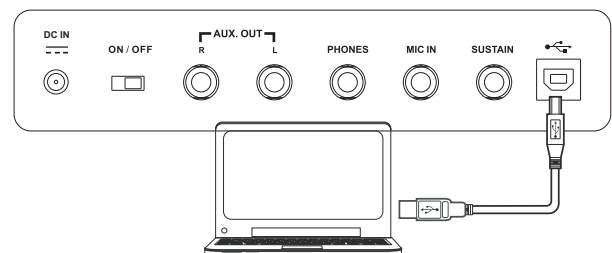

Playing the Demos

The instrument features 100 demo songs.

1. Press the [STYLE] and [VOICE] buttons simultaneously to start playing the demo.
2. Select a demo song.
Use the data dial, the number keys, the [+] button or the [-] button to select the desired demo song.

Adjust the volume with the [MASTER VOLUME] knob.

Press the [STYLE] and [VOICE] buttons simultaneously again or press the [START/STOP] button to stop playing and exit the demo mode.

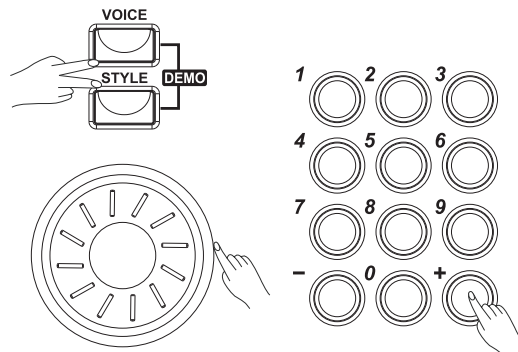

Note:

In the DEMO mode, all buttons except START/STOP, TEMPO+, TEMPO-, +, -, DSP, VOLUME, POWER ON/OFF will not be available.

Playing Voices

The instrument features 300 voices, including 3 drum kits. Please refer to **Voice List**.

Selecting a Voice

1. Press the [VOICE] button.
Enter the VOICE mode. LCD shows "VOICE R1", the voice number and the voice name.



2. Select a voice.
Use the data dial, the number keys, the [+] button or the [-] button to select the voice you want to play.

3. Play the voice.
You can play the keyboard and listen to the selected voice.

Note:

While changing a voice, pay attention to the rules. If you press the VOICE button, the voice will be changed between Voice R1 and Voice R2 when the dual voice is on.

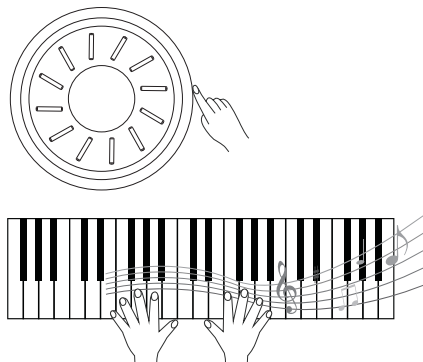

Playing Two Voice Simultaneously-DUAL

1. Press the [DUAL] button.

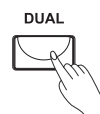

2. Play the voices.
Two different voices are sounded simultaneously in a layer.
The number of the dual voice will be displayed on the LCD.
3. Selecting a voice for VOICE R2.
When the number of the dual voice is displayed, you can select a voice for Voice R2. Use the data dial, the number keys, the [+]
button or the [-] button.

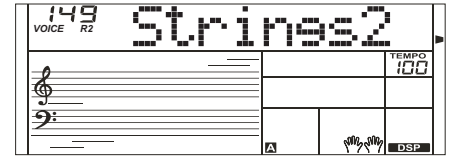

Touch

The keyboard is equipped with a touch response feature that lets you dynamically and expressively controls the level of the voice with your playing strength – just as on an acoustic instrument. Press the [TOUCH] button to turn the touch response on and off.

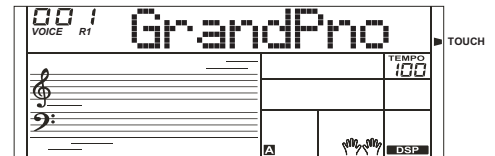

Sustain

When the Sustain feature is ON, all notes played on the keyboard would have a longer sustain. Press the [SUSTAIN] button to turn the SUSTAIN effect ON or OFF.

Note:

When you step on the “sustain pedal”, the sustain effect is stronger than the effect by pressing the [SUSTAIN] button.

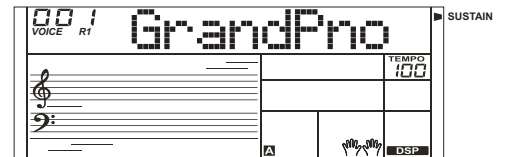

Pitch Bend Wheel

Use the pitch bend wheel to bend notes up (roll the wheel away from you) or down (roll the wheel toward you) while playing the keyboard. The pitch bend wheel is self-centering and will automatically return to normal pitch when released.

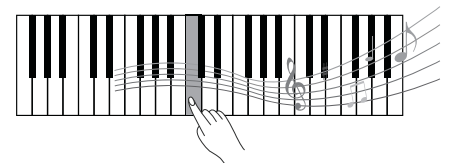

DSP Effect

This function allows you to perform the overall sound in a more realistic effect.

The DSP effect is set to ON when keyboard power on. Press the [DSP] button to turn on or off the DSP effect.

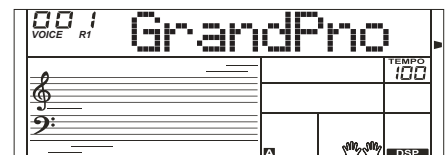

Playing the Voices

Transpose

Transpose function allows the overall pitch of the instrument to be transposed up or down by a maximum of 6 semitone increments.

1. Press the [TRANSPOSE +] or [TRANSPOSE -] button. The LCD show that the transpose value ranging from -6 to 6.
2. Use the data dial, the [TRANSPOSE +] button or the [TRANSPOSE -] button to change the transpose value.
3. Press the [TRANSPOSE +] and [TRANSPOSE -] buttons simultaneously to reset the transpose to 0.

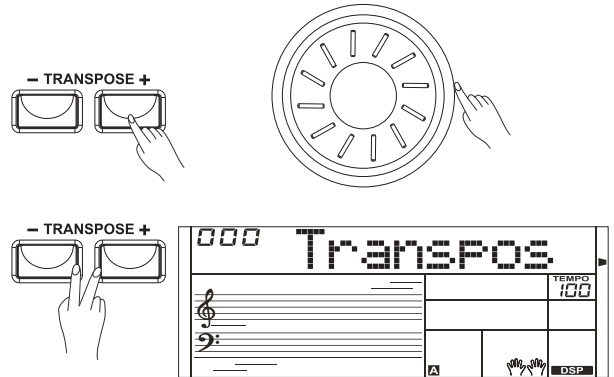

Octave

Octave function determines the relative octave setting for the keyboard-played voice R1, R2.

1. Press the [OCTAVE +] or [OCTAVE -] button. The LCD show that the octave value ranging from -1 to 1.
2. Use the data dial, the [OCTAVE +] button or the [OCTAVE -] button to change the octave value.
3. Press the [OCTAVE +] and [OCTAVE -] buttons simultaneously to reset the octave to 0.

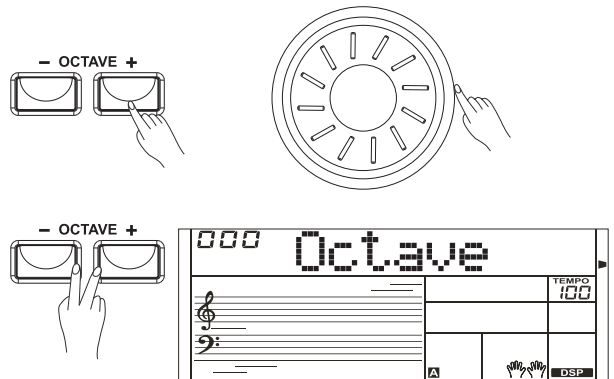

Playing the Styles

The instrument features 200 styles in a variety of different musical genres. Try selecting some of the different styles (Refer to **Style List**) and play with the auto accompaniment.

Selecting a style

1. Press the [STYLE] button.

Enter the STYLE mode. LCD shows "STYLE", the style number and the style name.

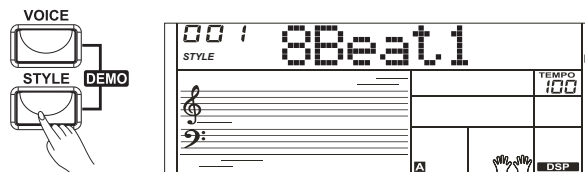

2. Use the data dial, the number keys, the [+] button, the [-] button to select the style you want to play.

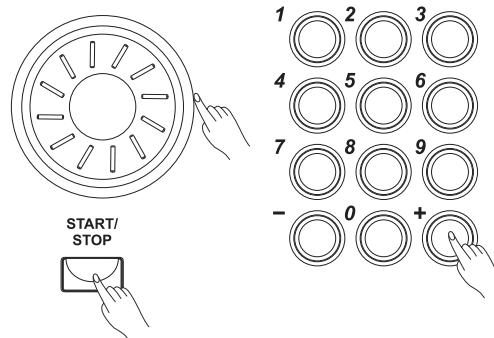

3. Press the [START/STOP] button to start the rhythm tracks of the auto accompaniment.

Playing a Fill

Auto fill in function automatically adds a fill to your performance. When the fill-in is finished, accompaniment shifts to the Main section (A,B).

Note:

Hold down the FILL-IN A/B button when the style is playing, the selected FILL pattern repeats continuously until button is released. Press FILL-IN A/B when style stop, it will change to the normal section, the icon A/B on LCD will be lightened.

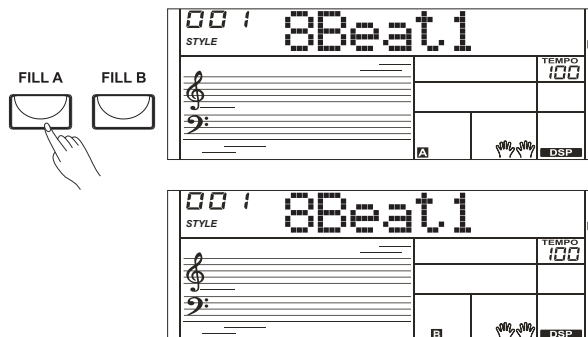

Intro/Ending

The intro is an opening section of the song. Each preset style features two different patterns. When the intro pattern finished, the system will automatically shift to the main section. Ending is used for the ending of the song. When the ending is finished, accompaniment automatically stops. The length of the ending differs depending on the selected style.

1. Press the [STYLE] button.
2. Select a style
3. Turn the Chord Mode on.
4. Turn SYNCHRONIZED START on.
5. Press the [INTRO/ENDING], the "A" or "B" flashes on LCD, the style is ready to play.
6. It will start the accompaniment as soon as you start playing in Chord section. When the playback of the intro is finished, it automatically leads into main A or B section.
7. Press the [INTRO/ENDING] again will lead it into the ending section. When the ending is finished, the auto accompaniment automatically stops.

Note:

Press [FILL A] or [FILL B] before the ending finished will lead it into main A or main B section.



Playing the Styles

Sync Start

While the style is not playing, press the [SYNC] button. The black dots below the tempo and the metronome flash, indicating the standby mode of the keyboard.

1. If the A.B.C. is OFF, pressing any key will automatically begins to play the style (rhythm track).
2. If the A.B.C. is ON, pressing any key in the left-hand range of the keyboard will automatically begins to play the style (all tracks).

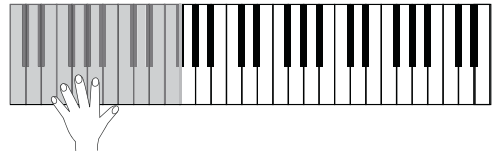

Fade In/Out

Fade In

Starting the style with fade in produces a smooth beginning, the volume increases from low to high.

Press the [FADE] button when Style is stopped, LCD will show FADE. Press the [START/STOP] button to start Style playing. LCD will show ▲FADE

The Accompaniment Volume will change from 0 to the Accompaniment Volume set value in about 8 seconds.

The keyboard volume will change from 0 to default value at the same time.

Fade Out

Stopping the style with fade out produces a smooth ending, the volume increases from high to low. Press the [FADE] button during Style playing. LCD will show FADE ▽

The Accompaniment Volume will change from the Accompaniment Volume set value to 0 in about 8 seconds, and the style stops.

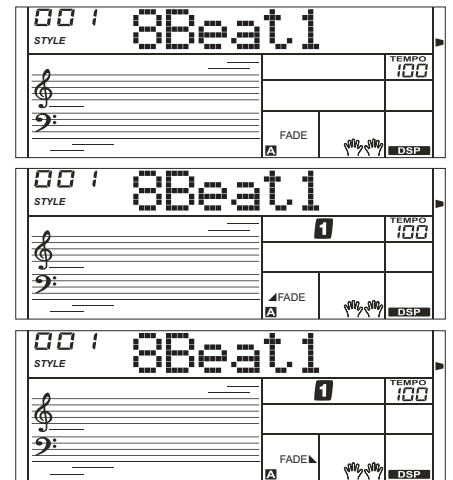
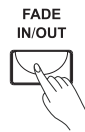

Accompaniment Volume

Adjust the volume of the accompaniment with the [ACC.VOL] buttons. Repeatedly press [ACC VOL+] or [ACC VOL-] to increase or decrease the volume. The volume ranges from 0 (no sound) to 31(Maximum) and the current accompaniment volume level appears on the display.

Note :

1. Press the [ACC VOL+] and [ACC VOL-] buttons simultaneously to reset the the volume of the accompaniment to 28.
2. While in DEMO, SONG or RECORD PLAY, [ACC.VOL] buttons can not use.

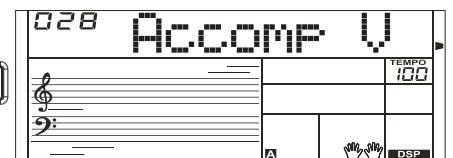
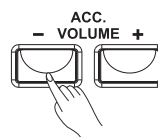

Tempo

Each style of the instrument has been programmed with a default tempo; however, this can be changed by using the [TEMPO+] or [TEMPO-] buttons.

1. Use the [TEMPO+] or [TEMPO-] button to change the tempo. The value ranges from 30 to 280.
2. Hold down the [TEMPO] buttons can change the tempo quickly. While the tempo is changing, the data dial can also change the tempo quickly.
3. Press the [TEMPO+] or [TEMPO-] buttons simultaneously to restore the default tempo setting.

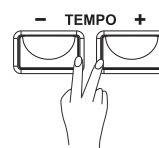
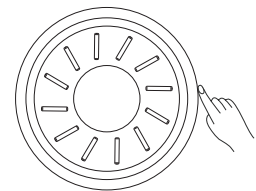
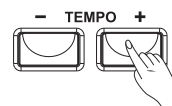

Auto Bass Chord

1. Press the [A.B.C.] button, LCD show "A.B.C.". The 19 keys on the left of the keyboard are called accompaniment keys. The accompaniment keys you pressed determine the type of chords that you played.

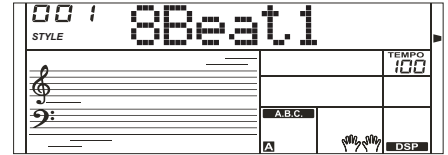

2. Press the accompaniment keys, the corresponding chord will display on LCD.

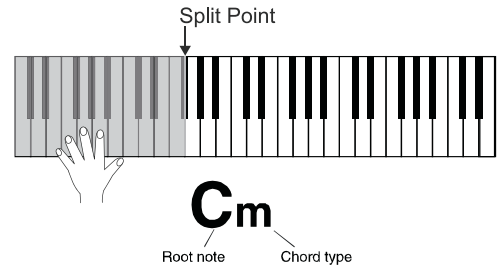

3. Split Point Set

Hold down [A.B.C.] button will enter in Split Point Set mode, LCD show "Split Pt" and the split point key number. Press keyboard set the split point key, and release the [A.B.C.] button, new split point key number is saved. The split point key and the other keys on the left of it are accompaniment keys.

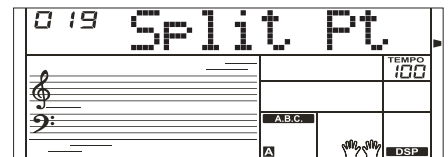

Single Finger

Single finger type not only can detect single finger but also can detect multi finger. And the single finger makes it easily to play chords through only one, two or three keys. Including major, minor, seventh, and minor seventh chord. Refer to relevant picture on the right for details.

	★ Major Triad Only press the root note on the keyboard.
	★ Minor Triad Press the root note and the nearest left black key simultaneously.
	★ Seventh chord Press the root note and the nearest left white key simultaneously.
	★ Minor seventh chord Press the root note and the nearest left white and black keys simultaneously.

Multi Finger

Multi finger type only can recognize those chords have listed in the chord list, and also can be found in the dictionary function.

0 C	1 C ₆	2 C _{M7}	3 C _{M7} (#11)	4 C _M (9)	5 C _{M7} (⁹)
6 C ₆ (⁹)	7 C _{aug}	8 C _m	9 C _{m6}	10 C _{m7}	11 C _{m7} (^{b5})
12 C _m (9)	13 C _{m7} (⁹)	14 C _{m7} (¹¹)	15 C _{mM7}	16 C _{mM7} (⁹)	17 C _{dim}
18 C _{dim7}	19 C ₇	20 C _{7sus4}	21 C ₇ (^{b5})	22 C ₇ (⁹)	23 C ₇ (#11)
24 C ₇ (¹³)	25 C ₇ (^{b9})	26 C ₇ (^{b13})	27 C ₇ (#9)	28 C _{M7aug}	29 C _{7aug}
30 C _{7sus4}	31 C ¹⁺²⁺⁵	Notes enclosed in parentheses are optional; the chords could be recognized without them.			

Playing the Styles

One Touch Setting

When One Touch Setting is switched on, you can instantly recall all auto accompaniment related settings including voices selection and digital effects simply with a single touch of a button.

1. Press the [O.T.S.] button to turn on the One Touch Setting for current style. LCD show O.T.S. 1.
2. Press one of the [ONE TOUCH SETTING] buttons [M1]-[M4]. Voice match the selected style can be instantly recalled with just a single button press.
3. A.B.C. is automatically turned on during O.T.S. mode.
4. Press the [O.T.S.] button again to quit One Touch Setting mode, "O.T.S." disappears.

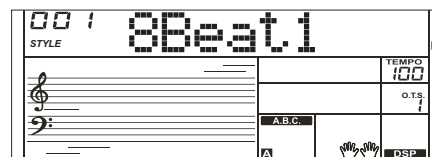
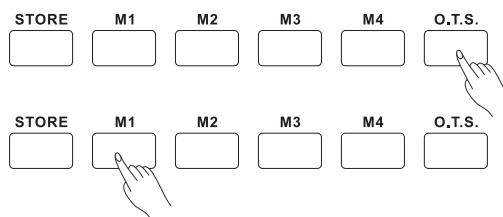

There are 4 memories (M1-M4).

1. While holding the [STORE] button, press one of the MEMORY buttons: [M1] - [M4] to register the panel settings. The new settings will replace the previous memory data. LCD show "Mem Stor". The settings include the number of voice, the number of style, tempo, beat value, sustain effect, etc.

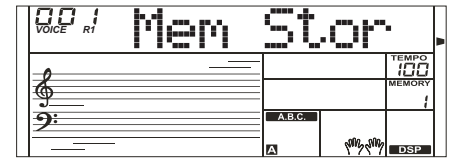

2. Press one of the MEMORY buttons: [M1] - [M4] to recall the panel settings.

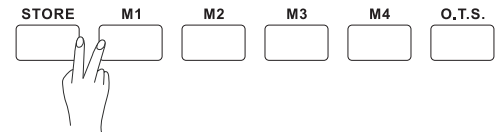

Note:

The stored settings can not be recalled when the One Touch Setting function is on. The stored settings will be returned to the default settings after you turned off the power.

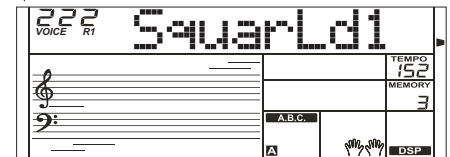

Chord Dictionary

If you know the name of a chord but don't know how to play it, you can use the Chord Dictionary function.

1. Press the [CHORD DICT.] button to enter this mode. The LCD displays the Chord Type and Chord Notes.
2. The key above G#3 are used to assign the Chord Type, the keys above C5 are used to assign the Chord Root. When the Chord Type and Chord Root are confirmed, the LCD will display the Chord and its staff position.
3. Play the chords on the keyboard according to the display. If you press the correct notes, you will hear a prompt applause sound.
4. Press the [CHORD DICT.] button again to exit this mode.

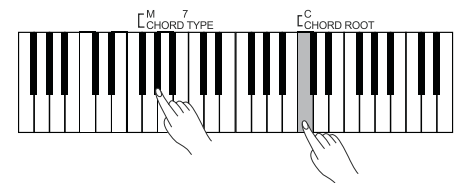
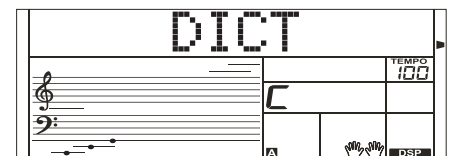

Metronome

Turning on the Metronome

Press the [METRO] button to turn on the metronome.

Press the [METRO] button again to turn off the metronome.

Press the [TEMPO+] / [TEMPO-] button to change the tempo of the metronome.



Selecting the Beat

Hold down [METRO] button will enter in Beat Set Mode. LCD show "Beat" and beat value. Press number keys(0 and 2-9), and release the [METRO] button, new beat value is saved. The default value is 4.

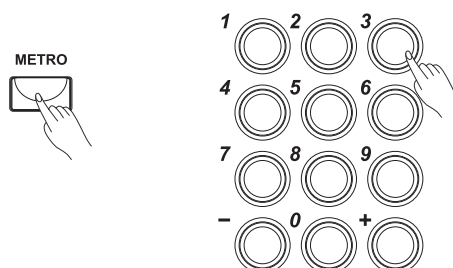

Playing the Songs

The instrument features 100 songs (Refer to **Song List**). Each song can be practiced in LESSON mode.

Listening to the Songs

1. Press the [SONG] button to enter the song mode. It will play all songs circularly. Press the [SONG] button again, it will stop the song and exit the song mode.
2. In song mode, use the data dial, the number keys and [+] or [-] button to select a song.
3. Once you start playing a song by pressing [START/STOP] button, it will play current song repeatedly. Press the [START/STOP] button again, it will stop the current song but not exit the song mode.
4. Use the [TEMPO+] or [TEMPO-] button to change the tempo of the current song.
5. When the song is stopped, press [STYLE], [VOICE], [DUAL], [M1] - [M4] to exit the song mode.

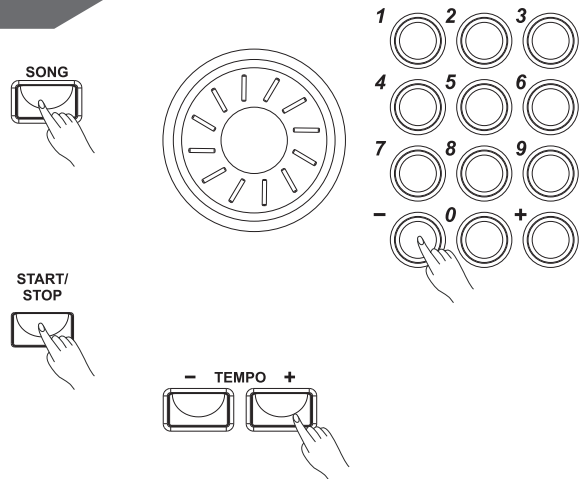

Lesson Mode

In the instrument, there are 3 different ways to practice the songs: time value training, note correction training, melody off. And the keyboard has a grading system to help you to know well about your progress.

1. In Song mode, press the [LESSON] button to enter the lesson mode or switch the lesson mode.
 2. Press the [START/STOP] button to start learning. The LCD will display the note need to be played.
 3. Press the [START/STOP] button again to stop learning.
 4. There are 3 lesson modes and a grading system.
 - Lesson 1:** the keyboard only grade the time value of the playing, don't care the correction of the note.
 - Lesson 2:** the keyboard only grades your practice by the note; doesn't care about the correctness of the timing. Only when you play the correct note, the song will continue to the next note.
 - Lesson 3:** the keyboard will score your practice by the correction of the time value and note.
- Grade:** In lesson mode, when you finished learning the current the song, the keyboard will play the prompt sound to tell you the level you get.
- Level 1:** Ok
 - Level 2:** Good
 - Level 3:** Very Good
 - Level 4:** Excellent

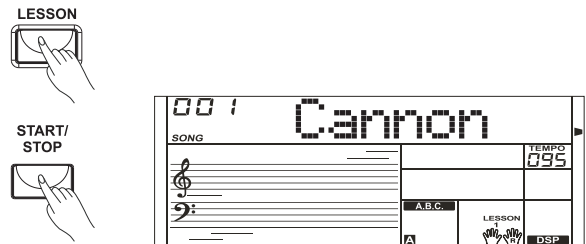

After grading, the song will be playing again, you can learn it again.

Recording and Playback

You can record your performance (up to 500 notes), and the accompaniment.

1. Press the [RECORD] button, the record flag appears on the left of LCD, the beat flashes.
2. Play the notes you want to record or press the [START/STOP] button to start recording. If you want to record your performance accompanied with the style, please turn on the A.B.C, and play the chords on the left of the keyboard.
3. Press the [RECORD] button again to stop recording. The record flag disappears.
4. Press the [PLAY] button to play the notes you recorded. The play flag appears on the left of LCD.
5. Press the [PLAY] button again to stop it. The play flag disappears.
6. When recording, press [PLAY] button can stop recording and play the notes you recorded.

Note:

If you turned off the keyboard, the data you have recorded will be lost.

RECORD



START/STOP

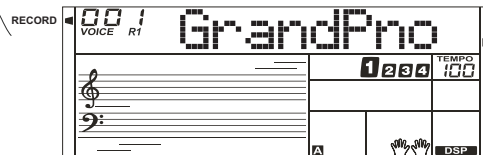

PLAY

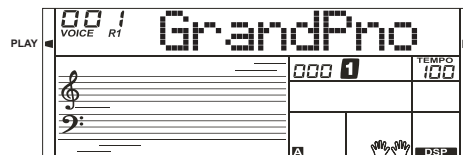

By using the MIDI functions you can expand your musical possibilities. This section explains what MIDI is, and what it can do, as well as how you can use MIDI on your instrument.

What's MIDI?

MIDI (short for Musical Instrument Digital Interface) allows a wide variety of electronic musical instruments, computers and other related devices to connect and communicate with one another. MIDI carries event messages that specify notation, pitch and velocity, control signals for parameters such as volume, vibrato, audio panning, and program change information to change the voice selections.

The instrument can output the real-time playback information via MIDI and control external MIDI devices. The instrument can also accept incoming MIDI messages and generate sound accordingly.

MIDI Terminals

MIDI Connection

The electronic keyboard is equipped with a standard USB interface instead of conventional MIDI IN and MIDI out connectors. The USB interface allows the keyboard to be connected to a computer without the need to separately purchase a MIDI interface for the computer. Most computers will automatically recognize the keyboard as a MIDI interface, allowing MIDI messages to be received from, or sent to, music programs running on the computer. To connect the keyboard to a computer you will need a standard USB A-B cable and suitable software such as a music sequencing program.

Note:

Activate the computer from a sleep/suspended/standby mode before connecting the USB cable.
Connect the USB cable to the instrument and a computer before turning the power of the instrument on.

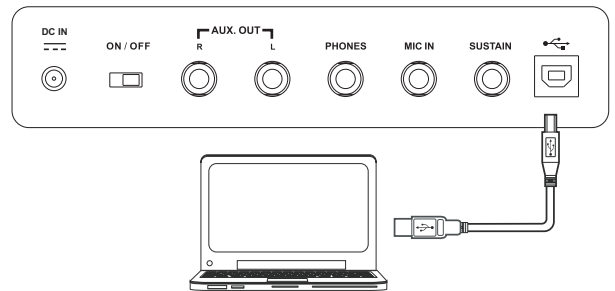

Trouble Shooting

Problem	Possible Cause and Solution
The speakers produce a “pop” sound whenever the power is turned ON or OFF.	This is normal and is no cause for alarm.
No sound results when the keyboard is played.	Make sure the master volume is set at appropriate levels.
When using a mobile phone, noise is produced.	Using a mobile phone in close proximity to the instrument may produce interference. To prevent this, turn off the mobile phone or use it further away from the instrument.
The auto accompaniment does not play back even Sync is in standby condition and a key is pressed.	You may be trying to start accompaniment by playing a key in the right-hand range of the keyboard. To start the accompaniment with Sync Start, make sure to play a key in the left-hand range of the keyboard.

Specifications

Keyboard

61

Display

Multi-functional LCD

Polyphony

32

Voice

300, including 3 drum kits

Style

200

Song

100

Demo

100

Tempo

30-280

Registration Memory

4

Control button

Power on/off switch, ACC.Vol+/-, Tempo+/-, ChordDict, Lesson, L/R Part, DSP, Style, Voice, Song, Memory, M1-M4, O.T.S., Dual, Sustain, Touch, Metro, Octave+/-, Transpose+/-, +, -

Accompaniment Control

Start/Stop, Sync Start, Intro/Ending, Fill A, Fill B, Fade In/Out, A.B.C.

Record Function

Record, Play

Connectors

DC IN, AUX.OUT, Phones, USB, MIC IN, Sustain

Power Supply

DC IN

Speaker

4Ω 10W + 10W

Dimensions

955 X 360 X 145mm

Weight

5.5Kg(without batteries)

* All specifications and appearances are subject to change without notice.

No	Name	LCD Name
PIANO		
1	Acoustic Grand Piano	GrandPno
2	Piano Dark	GrandPnD
3	Octave Piano 1	OctPno1
4	Octave Piano 2	OctPno2
5	Piano & Choir	Pno&Cho
6	Grand Piano / W	GrandPnW
7	Bright Piano 1	BritPno1
8	Bright Piano 2	BritPno2
9	Stereo Bright Piano	BritePnS
10	Detuned Piano	DetunEP
11	Chorus Piano	ChoruPno
12	Bright Piano 1 / W	BritPnW1
13	Bright Piano 2 / W	BritPnW2
14	Piano & Vibraphone	Pno&Vib
15	Electric Grand Piano	E.Piano
16	Electric Grand Piano / W	E.PianoW
17	Honky-Tonk Piano	HnkyTonk
18	Honky-Tonk Dark	HnkTonkD
19	Honky-Tonk 1 / W	HnkyTkW1
20	Honky-Tonk 2 / W	HnkyTkW2
21	E.Piano 1	E.Piano1
22	Stereo E.Piano 1	EPiano1S
23	50's E.Piano	50'sEP
24	E.Piano 1 / W	EPianoW1
25	E.Piano 2 / W	EPianoW2
26	E.Piano 3 / W	EPianoW3
27	E.Piano 4 / W	EPianoW4
28	E.Piano 2	E.Piano2
29	Detuned E.P. 1	DetunEP1
30	Detuned E.P. 2	DetunEP2
31	Harpsichord	Harpsi
32	Harpsichord / W	HarpsiW
33	Harpsichord Octave 1	HarpsiO1
34	Harpsichord Octave 2	HarpsiO2
35	Harpsichord Off	HarpsiOf
36	Clavichord	Clavi
37	Stereo Clavichord	ClaviS
38	Clavichord / W	ClaviW
39	Clavichord Wah	ClaviWa
MALLET		
40	Celesta	Celesta
41	Dark Celesta	CelestaD
42	Celesta & Sine	Cele&Sin
43	Reecho Bell	ReBell
44	Celesta & Music Box	Cel&Mbox
45	Glockenspiel	Glocken
46	Glockenspiel & Sine	Glnk&Sin
47	Music Box	MusicBox
48	Vibraphone	Vibra
49	Vibraphone / W	VibraW
50	Vibraphone & Bell	Vibr&Bel
51	Vibraphone & Harpsichord	Vibr&Hrp
52	Marimba	Marimba
53	Marimba / W	MarimbaW
54	Sine Marimba	Marm&Sin
55	Stereo Marimba	MarimbaS
56	Marimba & Vibraphone	Marm&Vib
57	Wood Drum	WoodDrum

58	Xylophone	Xylophon
59	Tubular Bells 1	TubuBel1
60	Tubular Bells 2	TubuBel2
61	Tubular Bells 3	TubuBel3
62	Dulcimer	Dulcimer
ORGAN		
63	Drawbar Organ	DrawOrg
64	Drawbar Organ Stereo	DrawOrgS
65	Soft Stereo Drawbar Organ	DrawOgSf
66	Mellow Drawbar Organ	MellOrg
67	Bright Drawbar Organ	DrawOrgB
68	Percussive Organ	PercOrgn
69	Percussive Organ Detuned	DePerOrg
70	Rock Organ	RockOrgn
71	Church Organ	ChurOrgn
72	Detuned Church Organ	DeChuOrg
73	Octave Church Organ 1	ChrOrgO1
74	Octave Church Organ 2	ChrOrgO2
75	Reed Organ	ReedOrgn
76	Stereo Reed Organ	ReedOrgS
77	Accordion 1	Acordin1
78	Accordion 2	Acordin2
79	Stereo Accordion	AcordinS
80	Harmonica	Harmnica
81	Dark Harmonica	HarmnicD
82	Tango Accordion	TangoAcD
83	Dark Tango Accordion	TangAcD
GUITAR		
84	Nylon Guitar	NylonGtr
85	Chorus Nylon Guitar	NylonGtC
86	Stereo Nylon Guitar	NylonGtS
87	Steel Guitar	SteelGtr
88	12 Strings Guitar	12StrGtr
89	Detuned Steel Guitar	DetStlGt
90	Jazz Guitar	JazzGtr
91	Clean Guitar	CleanGtr
92	Stereo Clean Guitar	CleanGtS
93	Soft Clean Guitar	ClnGtSof
94	Chord Clean Guitar	ClnGtCho
95	Muted Guitar	MutedGtr
96	Stereo Muted Guitar	MutedGtS
97	Chord Muted Guitar	MutGtCho
98	Overdriven Guitar	Ovrdrive
99	Distortion Guitar	DistGtr
100	Guitar Harmonics	GtrHarmo
BASS		
101	Acoustic Bass 1	AcoBass1
102	Acoustic Bass 2	AcoBass2
103	Acoustic Bass Detuned	DetAcoBs
104	Velocity Crossfade Bass	VelCroBs
105	Jazz Style	JazzSty
106	A.Bass & Mute G.T.	ABs&MtGT
107	Finger Bass 1	FngrBs1
108	Finger Bass 2	FngrBs2
109	Dark Finger Bass	FngrBsD
110	Detuned Finger Bass	DetFngBs
111	Velocity Bass	VelBass
112	Bass & Distortion Guitar	Bs&DisGt
113	Pick Bass 1	PickBs1
114	Pick Bass 2	PickBs2

115	Mute Pick Bass	PickBsM
116	Pick & Finger Bass	Pk&FgBs
117	Pick Bass & Clean Guitar	PBs&ClGt
118	Detuned Pick Bass	DetPkBs
119	Fretless Bass 1	Fretles1
120	Fretless Bass 2	Fretles2
121	Slap Bass 1	SlapBas1
122	Slap Bass 2	SlapBas2
123	Slap Bass 3	SlapBas3
124	Slap Bass 4	SlapBas4
125	Synth Bass 1	SynBass1
126	Synth Bass 2	SynBass2
127	Synth Bass 3	SynBass3
128	Synth Bass 4	SynBass4
STRINGS		
129	Violin 1	Violin1
130	Violin 2	Violin2
131	2 Violin	2Violin
132	Viola 1	Viola1
133	Viola 2	Viola2
134	2 Viola	2Viola
135	Cello 1	Cello1
136	Cello 2	Cello2
137	Contrabass 1	Contrbs1
138	Contrabass 2	Contrbs2
139	Tremolo Strings 1	TremStr1
140	Tremolo Strings 2	TremStr2
141	Pizzicato Strings 1	PizzStr1
142	Pizzicato Strings 2	PizzStr2
143	Orchestral Harp 1	Harp1
144	Orchestral Harp 2	Harp2
145	Stereo Harp	HarpS
146	Timpani 1	Timpani1
147	Timpani 2	Timpani2
MALLET		
148	Strings Ensemble 1	Strings1
149	Strings Ensemble 2	Strings2
150	Stereo Strings 1	StringS1
151	Stereo Strings 2	StringS2
152	Synth Strings 1	SynStrs1
153	Synth Strings 2	SynStrs2
154	Synth Strings 3	SynStrs3
155	Stereo Synth Strings 1	SynStrS1
156	Stereo Synth Strings 2	SynStrS2
157	Choir Aahs	ChoirAah
158	Dark Aahs	ChoAhD
159	Stereo Aahs 1	ChoAhS1
160	Stereo Aahs 2	ChoAhS2
161	Mellow Choir Aahs	ChoAhMel
162	Aahs & SynStr	Ah&SyStr
163	Big Aahs	BigAahs
164	Voice Ooh	VoiceOoh
165	Synth Voice 1	SynVoic1
166	Synth Voice 2	SynVoic2
167	Stereo Synth Voice	SynVoicS
168	Orchestra Hit	OrchHit
169	Orchestra Hit Stereo	OrchHitS
170	Orchestra Hit Octave	HitOctO
BRASS		
171	Trumpet 1	Trumpet1

Voice List

172	Trumpet 2	Trumpet2
173	Dark Trumpet	TrumpetD
174	Wah Trumpet	TrumpetW
175	Trombone 1	Trmbone1
176	Trombone 2	Trmbone2
177	Tuba 1	Tuba1
178	Tuba 2	Tuba2
179	Muted Trumpet 1	MuteTrp1
180	Muted Trumpet 2	MuteTrp2
181	Horn 1	Horn1
182	Horn 2	Horn2
183	5th Horn Orchestra	5thHorn
184	Brass Ensemble	Brass
185	Synth Brass 1	SynBras1
186	Synth Brass 2	SynBras2
187	Synth Brass 3	SynBras3
188	Synth Brass 4	SynBras4
189	Synth Brass 5	SynBras5
190	Octave Synth Brass	SynBrasO
REED		
191	Soprano Sax 1	SprnSax1
192	Soprano Sax 2	SprnSax2
193	Alto Sax 1	AltoSax1
194	Alto Sax 2	AltoSax2
195	Tenor sax 1	TenoSax1
196	Tenor sax 2	TenoSax2
197	Baritone Sax 1	BariSax1
198	Baritone Sax 2	BariSax2
199	Oboe	Oboe
200	Sweet Oboe	SwetOboe
201	English Horn 1	EngHorn1
202	English Horn 2	EngHorn2
203	Bassoon 1	Bassoon1
204	Bassoon 2	Bassoon2
205	Clarinet 1	Clarinet1
206	Clarinet 2	Clarinet2
PIPE		
207	Piccolo	Piccolo
208	Flute 1	Flute1
209	Flute 2	Flute2
210	Recorder 1	Recordr1
211	Recorder 2	Recordr2
212	Pan Flute 1	PanFlut1
213	Pan Flute 2	PanFlut2
214	Blown Bottle 1	Bottle1
215	Blown Bottle 2	Bottle2
216	Shakuhachi 1	Shakchi1
217	Shakuhachi 2	Shakchi2
218	Whistle 1	Whistle1
219	Whistle 2	Whistle2
220	Ocarina 1	Ocarina1
221	Ocarina 2	Ocarina2

LEAD		
222	Square Lead 1	SquarLd1
223	Square Lead 2	SquarLd2
224	Square Lead 3	SquarLd3
225	Lead Sine	SineLead
226	Slow Square Lead	SawLead
227	Thick Square	ThickSq
228	Quint	Quint
229	Sine Solo	SineSolo
230	Sawtooth Lead 1	SawLead1
231	Sawtooth Lead 2	SawLead2
232	Stereo Sawtooth 1	SawLdS1
233	Stereo Sawtooth 2	SawLdS2
234	5th Sawtooth	5thSaw
235	Calliope Lead 1	CalipLd1
236	Calliope Lead 2	CalipLd2
237	Chiff Lead 1	ChiffLd1
238	Chiff Lead 2	ChiffLd2
239	Charang Lead 1	CharnLd1
240	Charang Lead 2	CharnLd2
241	Voice Lead 1	VoicLd1
242	Voice Lead 2	VoicLd2
243	Fifths Lead	FifthsLd
244	Bass & Lead 1	Bs&Lead1
245	Bass & Lead 2	Bs&Lead2
PAD		
246	New Age Pad 1	NewAgPd1
247	New Age Pad 2	NewAgPd2
248	Warm Pad 1	WarmPad1
249	Warm Pad 2	WarmPad2
250	Poly Synth Pad 1	PlySyPd1
251	Poly Synth Pad 2	PlySyPd2
252	Choir Pad 1	ChoPad1
253	Choir Pad 2	ChoPad2
254	Bowed Pad 1	BowdPad1
255	Bowed Pad 2	BowdPad2
256	Metallic Pad	MetalPad
257	Halo Pad	HaloPad
258	Sweep Pad	SweepPad
EFFECTS		
259	Rain	FXRain
260	Soundtrack	Soundtrk
261	Crystal	Crystal
262	Atmosphere	Atmosphr
263	Brightness	Bright
264	Goblins	Goblins
265	Echoes	Echoes
266	Sci-Fi	Sci-Fi
ETHNIC		
267	Sitar	Sitar
268	Detuned Sitar	DetSitar
269	Banjo 1	Banjo1

270	Banjo 2	Banjo2
271	Shamisen 1	Shamisin1
272	Shamisen 2	Shamisin2
273	Koto 1	Koto1
274	Koto 2	Koto2
275	Kalimba 1	Kalimba1
276	Kalimba 2	Kalimba2
277	Bagpipe	Bagpipe
278	Fiddle	Fiddle
279	Shania	Shania
PERCUSSIVE		
280	Tinkle Bell	TnklBell
281	Agogo	Agogo
282	Steel Drums	StelDrum
283	Bass Drum	BassDrum
284	Wood Block	WoodBlok
285	Snare	Snare
286	Taiko Drum	TaikoDrm
287	Melodic Tom	MelodTom
288	Synth Drum	SynDrum
289	Reverse Cymbal	RevCymb1
290	Guitar Fret Noise	FretNoiz
SYNTH		
291	Breath Noise	BrthNoiz
292	Seashore	Seashore
293	Bird Tweet	Tweet
294	Telephone Ring	Telephone
295	Helicopter	Helicptr
296	Applause	Applause
297	Gunshot	Gunshot
DRUM SET		
298	Standard Drum Set	StandSet
299	Rock Drum Set	RockSet
300	Electronic Drum Set	ElecSet

No	Name	LCD Name
BEAT & POP 1		
1	8 Beat 1	8Beat1
2	8 Beat 2	8Beat2
3	8 Beat 3	8Beat3
4	8 Beat 4	8Beat4
5	60's 8 Beat	60's8Bt
6	8 Beat Ballad	8BtBld
7	8 Beat Rock	8BtRock
8	16 Beat 1	16Beat1
9	16 Beat 2	16Beat2
10	16 Beat Pop	16BtPop
11	16 Beat Shuffle	16BtShfl
12	Ballad	Ballad
13	Slow Ballad	SlowBld
14	16 Beat Ballad	16BtBld
15	Unplugged	Unplugged
ROCK 1		
16	Rock	Rock
17	Pop Rock	PopRock
18	Fast Rock	FastRock
19	Slow Rock 1	SlwRock1
20	Slow Rock 2	SlwRock2
21	Rock & Roll	RockRoll
22	Heavy Metal	H.Metal
23	Blues Boogie	B.Boogie
24	Blues	Blues
25	Shuffle	Shuffle
26	Blues Shuffle	B.Shuffle
27	Rock Shuffle	R.Shuffle
28	Charleston	Charston
DANCE 1		
29	Disco 1	Disco1
30	Disco 2	Disco2
31	Disco Funk	DiscFunk
32	Dance	Dance
33	House 1	House1
34	House 2	House2
35	Rap	Rap
36	Euro Beat	EuroBeat
37	Hip Hop	HipHop
38	Techno	Techno
SOUL & FUNK 1		
39	Funky Pop	FunkyPop
40	Jazz Funk	JazzFunk
41	Cool Funky	CoolFunk
42	Soul 1	Soul1
43	Soul 2	Soul2
44	Soul Shuffle	SoulShfl
45	Soul Blues	SoulBlue
46	R & B	R&B
47	6/8 Gospel	6/8Gospl
48	Pop Groove	PopGrove
JAZZ 1		
49	Swing	Swing
50	Cool Jazz	CoolJazz
51	Pop Swing	PopSwing
52	Swing Fox	SwingFox
53	Big Band	BigBand
54	Big Band Medium	BandMedi

56	Ragtime	Ragtime
57	Dixieland	Dixeland
58	Quick Step	QuickStp
COUNTRY 1		
59	Country 1	Country1
60	Country 2	Country2
61	Pop Country	PopCntry
62	Country Rock	CtryRock
63	Country Folk	CtryFolk
64	3/4 Country	3/4Ctry
65	Country Waltz	C.Waltz
66	Country Shuffle	CtryShfl
67	Country Boogie	C.Boogie
68	Country Blues	C.Blues
69	Country Quick Step	CtryStep
70	Bluegrass	Bluegras
LATIN 1		
71	Bossa Nova 1	Bossa1
72	Bossa Nova 2	Bossa2
73	Rhumba	Rhumba
74	Pop Rhumba	P.Rhumba
75	Cha Cha	ChaCha
76	Pop Cha Cha	P.ChaCha
77	Tango	Tango
78	Jazz Samba	JazSamba
79	Reggae	Reggae
80	Pop Reggae	P.Reggae
TRADITIONAL 1		
81	March 1	March1
82	March 2	March2
83	German March	G.March
84	6/8 March	6/8March
85	Polka	Polka
86	Pop Polka	PopPolka
87	Waltz	Waltz
88	Slow Waltz	SloWaltz
89	Vienna Waltz	VieWaltz
90	Musette	Musette
PIANO 1		
91	Piano 8 Beat	Pno8Beat
92	Piano Ballad	PnoBalad
93	Piano Boogie	PnoBogie
94	Piano Jazz	PnoJazz
95	Piano Swing	PnoSwing
96	Piano Jazz Waltz	P.JWaltz
97	Piano Twist	PnoTwist
98	Piano March	PnoMarch
99	Piano 6/8 March	Pno6/8Mr
100	Piano Waltz	PnoWaltz
BEAT & POP 2		
101	8 Beat 1-1	8Beat1-1
102	8 Beat 2-1	8Beat2-1
103	8 Beat 3-1	8Beat3-1
104	8 Beat 4-1	8Beat4-1
105	60's 8 Beat 1	60's8Bt1
106	8 Beat Ballad 1	8BtBld1
107	8 Beat Rock 1	8BtRock1
108	16 Beat 1-1	16Bt1-1
109	16 Beat 2-1	16Bt2-1
110	16 Beat Pop 1	16BtPop1

111	16 Beat Shuffle 1	16BtShf1
112	Ballad 1	Ballad1
113	Slow Ballad 1	SlowBld1
114	16 Beat Ballad 1	16BtBld1
115	Unplugged 1	Unplug1
ROCK 2		
116	Rock 1	Rock1
117	Pop Rock 1	PopRock1
118	Fast Rock 1	FastRk1
119	Slow Rock 1-1	SlwRk1-1
120	Slow Rock 2-1	SlwRk2-1
121	Rock & Roll 1	RkRoll1
122	Heavy Metal 1	H.Metal1
123	Blues Boogie 1	B.Bogie1
124	Blues 1	Blues1
125	Shuffle 1	Shuffle1
126	Blues Shuffle 1	B.Shuff1
127	Rock Shuffle 1	R.Shuff1
128	Charleston 1	Charstn1
DANCE 2		
129	Disco 1-1	Disco1-1
130	Disco 2-1	Disco2-1
131	Disco Funk 1	DiscoFk1
132	Dance 1	Dance1
133	House 1-1	House1-1
134	House 2-1	House2-1
135	Rap 1	Rap1
136	Euro Beat 1	EuropBt1
137	Hip Hop 1	HipHop1
138	Techno1	Techno1
SOUL & FUNK 2		
139	Funky Pop 1	FunkPop1
140	Jazz Funk 1	JazzFK1
141	Cool Funky 1	CoolFk1
142	Soul 1-1	Soul1-1
143	Soul 2-1	Soul2-1
144	Soul Shuffle 1	SoulShf1
145	Soul Blues 1	SoulBlu1
146	R & B 1	R&B1
147	6/8 Gospel 1	6/8Gosp1
148	Pop Groove 1	PopGrov1
JAZZ 2		
149	Swing 1	Swing1
150	Cool Jazz 1	CoolJz1
151	Pop Swing 1	PopSwin1
152	Swing Fox 1	SwinFox1
153	Big Band 1	BigBand1
154	Big Band Medium 1	BandMed1
155	Jazz Waltz 1	JzWaltz1
156	Ragtime 1	Ragtime1
157	Dixieland 1	Dixland1
158	Quick Step 1	QuickSp1
COUNTRY 2		
159	Country 1-1	Cntry1-1
160	Country 2-1	Cntry2-1
161	Pop Country 1	PopCtry1
162	Country Rock 1	CtryRk1
163	Country Folk 1	CtryFok1
164	3/4 Country 1	3/4Ctry1
165	Country Waltz 1	C.Waltz1

Style List

166	Country Shuffle 1	CtryShf1
167	Country Boogie 1	C.Boogie1
168	Country Blues 1	C.Blues1
169	Country Quick Step 1	CtryStp1
170	Bluegrass 1	Bluegra1
LATIN 2		
171	Bossa Nova 1-1	Bossa1-1
172	Bossa Nova 2-1	Bossa2-1
173	Rhumba 1	Rhumba1
174	Pop Rhumba 1	P.Rhumb1
175	Cha Cha 1	ChaCha1
176	Pop Cha Cha 1	P.ChaCa1
177	Tango 1	Tango1

178	Jazz Samba 1	JzSamba1
179	Reggae 1	Reggae1
180	Pop Reggae 1	P.Reggae1
TRADITIONAL 2		
181	March 1-1	March1-1
182	March 2-1	March2-1
183	German March 1	G.March1
184	6/8 March 1	6/8Marc1
185	Polka 1	Polka1
186	Pop Polka 1	PopPoka1
187	Waltz 1	Waltz1
188	Slow Waltz 1	SlWaltz1
189	Vienna Waltz 1	ViWaltz1

190	Musette 1	Musette1
PIANO 2		
191	Piano 8 Beat 1	Pno8Bt1
192	Piano Ballad 1	PnoBald1
193	Piano Boogie 1	PnoBogi1
194	Piano Jazz 1	PnoJazz1
195	Piano Swing 1	PnoSwin1
196	Piano Jazz Waltz 1	P.JWalz1
197	Piano Twist 1	PnoTwis1
198	Piano March 1	PnoMarc1
199	Piano 6/8 March 1	Pno6/8M1
200	Piano Waltz 1	PnoWalz1

Song List

No.	Name	LCD Name
BEAT & POP 1		
1	Cannon	Cannon
2	Meditation	Meditati
3	Old French Song	France
4	Minuet In G	Minuet
5	Ode To Joy	OdeToJoy
6	Wiegenlied	WieGenli
7	The Surprise Symphony	Surprise
8	Swan Lake	SwanLake
9	The Four Seasons	F.Season
10	Carmen	Carmen
11	Joy To The World	JoyWorld
12	Toy Symphony	Toy
13	Humoreske	Humoresk
14	Kuckucks Walzer	Kuckucks
ROCK 1		
15	It's Been A Long, Long Time	LongAgo
16	Old Folks At Home	OldFolks
17	Oh! Susanna	Susanna
18	Jeanie With The Light Brown Hair	Jeannie
19	Bill Bailey, Won't You Please Come Home?	Billhome
20	Annie Laurie	Annielau
21	From The New World	NewWorld
22	The Yellow Rose Of Texas	RoseTexa
23	Ave Maria	AveMaria
24	My Old Kentucky Home	Kentucky
25	Turkey In The Straw	Turkey
26	Deck The Halls	DeckHall
27	Grandfather's Clock	G'sClock
28	America The Beautiful	America
29	The Sideway	Sideway
30	The Entertainer	Entertai
31	The Old Gray Mare	GrayMare
32	Aloha Oe	AlohaOe
33	Solvejg's Cradle Song	Solveig
34	Camptown Races	C.Races
35	Carry Me Back To Old Virginny	Viginia
36	The Blue Bells Of Scotland	BlueBell
37	O Sole Mio	OsoloMio
38	Jingle Bells	JingBell
39	Battle Hymn Of The Republic	Battle
40	Silent Night	SitNight
FOLK		
41	Огонек	Ogoniok
42	Aura Lea	AulaLee
43	House Of The Rising Sun	HouseSun
44	Danny Boy	DannyBoy
45	I've Been Working On The Railroad	WorkRail
46	With Games	WithGame
47	Way Home	WayHome
48	Parting	Parting
49	Yankee Doodle	YankeeD
50	Red River Valley	RedRiver

No.	Name	LCD Name
51	Auld Lang Syne	AuldLang
52	When The Saints Go Marching In	Marching
53	Twinkle Twinkle Little Star	Twinkle
54	Happy Birthday To You	Birthday
55	Little Brown Jug	BrownJug
56	Michael Row The Boat Ashore	RowBoat
57	Old King Cole	KingCole
58	Jamaica Farewell	Jamaica
59	Тройка	Troika
60	Cielito Lindo	Cielito
61	If You're Happy And You Know It	ClapHand
62	American Patrol	A.Patrol
63	When Johnny Comes Marching Home	ComeHome
64	Green Sleeves	Sleeves
65	Santa Lucia	SantaLu
66	Sweet Waltz	SweetWal
KID'S SONG		
67	Angels We Have Heard On High	Angels
68	Skip To My Lou	SkipMyLo
69	London Bridge Is Falling Down	Bridge
70	Humpty Dumpty	HumptyD
71	Home On The Range	HomeRang
72	This Old Man	OldMan
73	Star Bright	StarBri
74	Ten Little Indians	TenIndia
75	Polly Wolly Doodle	PlyWlyDo
76	Santa Claus Is Coming To Town	SantaCla
77	Sippin' Cider Through A Straw	SipinCid
78	La Cucaracha	Cucaraca
79	Home Sweet Home	SwetHome
80	Up On The House Top	HouseTop
BALLROOM		
81	Kuerchake Dance	Kulzak
82	Samba	Samba
83	Tango	Tango
84	Kazakhstan Dance	Kazakhst
85	Naughty Polka	Polka
PIANO & KEYBOARD		
86	Four Little Swans	FourSwan
87	Did You Ever See A Lassie	Lassie
88	Spring	Spring
89	Impromptu	Imprompt
90	Gavotte	Gavotte
91	Nocturne	Nocturne
92	Pizzicato Polka	Pizicato
93	Moment Musical	M.Moment
94	The Rag-Time Dance	Rag-Time
95	Love	Love
96	Valse No.6 "Petit Chien"	ValseNo6
97	Rondeau	Rondeau
98	The Chrysanthemum	Chrysanf
99	Invention A 2 Voix	Invetion
100	Afternoon	Afternoo

Chord List

Chord Name/[Abbreviation]	Normal Voicing	Chord (C)	Display
Major [M]	1-3-5	C	C
Major seventh [M7]	1-3-(5)-7	CM7	CM7
Major add ninth [Madd9]	1-2-3-5	CMadd9	CM(9)
Seventh [7]	1-3-(5)-b7	C7	C7
Seventh thirteenth[7 13]	1-3-(5)-6-b7 or 2-3-5-6-b7	C7 13	C7(13)
Minor seventh flatted fifth[m7b5]	1-b3-b5-b7	Cm7b5	Cm7b5
Major sixth [6]	1-(3)-5-6	C6	C6
Minor [m]	1-b3-5	Cm	Cm
Minor seventh [m7]	1-b3-(5)-b7	Cm7	Cm7
Minor major ninth [mM7]	1-b3-(5)-7	CmM7	CmM7
Minor sixth [m6]	1-b3-5-6	Cm6	Cm6
Augmented [aug]	1-3-#5	Caug	Caug
Diminished [dim]	1-b3-b5	Cdim	Cdim
Diminished seventh [dim7]	1-b3-b5-6	Cdim7	Cdim7
Suspended fourth [sus4]	1-4-5	Csus4	Csus4
Seventh suspended fourth [7sus4]	1-4-5-b7	C7sus4	C7sus4

MIDI Implementation Chart

Function		Transmitted	Recognized	Remarks
Basic Channel	Default	1ch	ALL	
	Changed	x	x	
Mode	Default	x	1	
	Messages	x	x	
	Altered	*****	x	
Note Number	Note	18—114	0—127	
	:True voice	*****	0—127	
Velocity	Note on	o 9nH,V=1-127	o 9nH,V=1-127	
	Note off	x (9nH,V=0)	x (9nH,V=0; 8nH,V=0-127)	
After Touch	key's	x	x	
	Ch's	x	x	
Pitch Bend		o	o	
Control Change	0	o	o	Bank Select
	1	x	o	Modulation
	5	x	x	Portamento Time
	6	x	o	Data Entry
	7	x	o	Volume
	10	x	o	Pan
	11	x	o	Expression
	64	o	o	Sustain Pedal
	65	x	x	Portamento ON/OFF
	66	x	o	Sostenuto Pedal
	67	x	o	Soft Pedal
	80	x	o	Reverb Program
	81	x	o	Chorus Program
	91	x	o	Reverb Level
	93	x	o	Chorus Level
	120	x	o	All Sound Off
	121	x	o	Reset All Controllers
	123	o	o	All Notes Off
	Program Change	:true	*****	0—127
System Exclusive		x	x	
System Common	:SongPosition	x	x	
	:Song Select	x	x	
	:Tune	x	x	
System Real Time	:Clock	x	x	
	:Commands	x	x	
Aux Messages	:LOCAL ON/OFF	x	x	
	:All Notes Off	o	o	
	:Active sense	x	o	
	:Reset	x	o	
Notes:				

- Mode 1: OMNI ON, POLY
- Mode 2: OMNI ON, MONO o: YES

- Mode 3: OMNI OFF, POLY
- Mode 4: OMNI OFF, MONO x: NO

